



## User's Guide

**TV-IP410**  
**TV-IP410W**  
A1.31

# PREFACE

---

The Pan/Tilt Internet Camera Server (TV-IP410) /Wireless Pan/Tilt Internet Camera Server (TV-IP410W) provides real-time security surveillance over a large viewing area. Monitor people in your camera's viewing field and manage the camera from any Internet connection.

See more with one Internet camera—remotely pan the camera side-to-side a remarkable 330 degrees and tilt up-and-down 105 degrees.

The TV-IP410/TV-IP410W provides high quality video streams over a secure or wireless connection. Advanced intuitive software includes motion detection recording, email alerts and scheduled recordings. This camera's brilliant image quality, pan and tilt functionality and low light recording capabilities make it ideal for home, small office and business use.

- Chapter 1 Introduction to Your Camera** describes the features of the camera. You will also know the components and functions of the camera.
- Chapter 2 Hardware Installation** helps you install the camera according to your application environment. You can use this camera at home, at work, at any where you want.
- Chapter 3 Accessing the Camera** lets you start using your camera without problem. The camera can be set up easily and work within your network environment instantly.
- Chapter 4 Configuring the Camera** guides you through the configuration of the camera using the Web browser on your PC.
- Chapter 5 SecurView Software** using the convenience software to monitor your camera

**Chapter 6 Appendix** provides the specification of the camera and some useful information for using your camera.

**NOTE** The illustrations and configuration values in this guide are for reference only. The actual settings depend on your practical application of the camera.

# Contents

PREFACE .....	1
CHAPTER 1 .....	5
INTRODUCTION.....	5
1.1 PACKAGE CONTENTS .....	5
1.2 GETTING TO KNOW YOUR CAMERA.....	6
1.3 FEATURES AND BENEFITS.....	8
1.4 SYSTEM REQUIREMENT.....	9
CHAPTER 2 .....	10
HARDWARE INSTALLATION.....	10
2.1 INSTALLING THE WALL MOUNT KIT.....	10
2.2 CONNECTING THE CAMERA TO LAN/WLAN.....	11
2.3 APPLICATIONS OF THE CAMERA.....	12
CHAPTER 3 .....	13
ACCESSING THE CAMERA.....	13
3.1 USING IPSETUP .....	13
3.2 ACCESSING TO THE CAMERA.....	18
3.3 CONFIGURING THE IP ADDRESS OF THE PC .....	22
CHAPTER 4 .....	24
CONFIGURING THE CAMERA.....	24
4.1 USING THE WEB CONFIGURATION.....	24
4.2 USING SMART WIZARD .....	25
4.3 BASIC SETUP .....	29
4.4 NETWORK SETTINGS.....	33
4.5 PAN/TILT SETTINGS.....	40
4.6 SETTING UP VIDEO .....	41
4.7 EVENT SERVER CONFIGURATION.....	45
4.8 MOTION DETECT.....	48
4.9 EVENT CONFIG .....	49
4.10 TOOLS.....	55
4.11 INFORMATION .....	57
CHAPTER 5 .....	58

SECURVIEW™ SOFTWARE .....	58
5.1 INSTALLATION .....	58
5.2 USING INSTALLATION .....	63
ITEM FEATURES .....	63
TO ADD A CAMERA .....	69
TO REMOVE A CAMERA .....	72
TO LINK TO THE WEB PAGE OF THE CAMERA.....	73
TO RECORD VIDEO .....	74
TO CONFIGURE THE RECORDING SETTINGS .....	79
TO PLAYBACK THE RECORDED VIDEO .....	81
TO SET UP MOTION DETECTION OPTIONS .....	82
ACCOUNT .....	84
OTHER.....	84
INFORMATION .....	85
APPENDIX.....	87
A.1 SPECIFICATION .....	87
A.2 GPIO TERMINAL APPLICATION.....	89
A.3 GLOSSARY OF TERMS.....	90
Limited Warranty.....	99

---

# CHAPTER 1

---

## INTRODUCTION

### 1.1 Package Contents

The package includes the following:

- TV-IP410 or TV-IP410W Camera
- CD-ROM (User's Guide and Utility)
- Multi-Language Quick Installation Guide
- External Antenna (for TV-IP422W only)
- GPIO Connector
- RJ-45 Cable
- 12V 1.5A Power Adapter (3.5mm)
- Wall Mount Kit

**NOTE:** If there is item missing, please contact your local authorized dealer.

## 1.2 Getting to Know Your Camera

**Adjustable LEDs**  
rotate the lens to have  
clear image.

**Antenna** for  
TV-IP410W  
only



**Power LED**  
indicates the camera  
is powered on with  
the steady amber  
light.

**Link LED**  
indicates the camera's  
network connectivity  
with the flashing green  
light.

**Front View**

### Ethernet Cable Connector

Connect to network by using the RJ-45 Cable. It also support the NWay protocol.

### External Antenna

Connects the external antenna.

### DC Power Connector

connects the AC power adapter, in order to supply power to the camera.

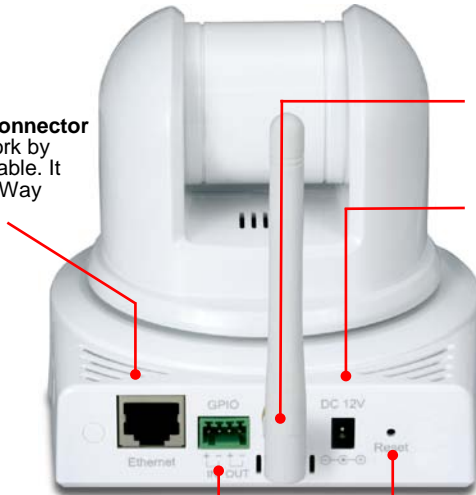

### GPIO Connectors

It is used to connect the external device.

### Reset Button

Press it quickly to restart the camera. Press and hold for 5 seconds to set to factory default.

## Rear View



## 1.3 Features and Benefits

### ■ **MJPEG Supported**

The camera provides you with excellent MJPEG images technology, allowing you to adjust image size and quality, and bit rate according to the networking environment.

### ■ **Optimal Viewing**

With the pan/tilt functions, you can easily monitor everywhere via the camera by moving the camera lens to the left/right (165/165 degrees) or up/down (90/15 degrees). In addition, you can assign up to eight positions for the camera, enabling you to move the camera lens to the desired position quickly.

### ■ **I/O Connectors Provided**

The camera provides the I/O connectors on the rear panel (IN/OUT), which provide the physical interface to send and receive digital signals to a variety of external alarm devices. You can connect a special featured device, and then configure the settings and control the device from the **GPIO Trigger** window of Web Configuration.

### ■ **Remote Control Supported**

By using a standard Web browser or the bundled SecurView software application, the administrator can easily change the configuration of the camera via Intranet or Internet. In addition, the camera can be upgraded remotely when a new firmware is available. The users are also allowed to monitor the image and take snapshots via the network.

### ■ **Multiple Platforms Supported**

The camera supports multiple network protocols, including TCP/IP, SMTP e-mail, HTTP, and other Internet related protocols. Therefore, you can use the camera in a mixed operating system environment, such as Windows 2000 and Windows XP and Windows Vista and Windows 7.

### ■ **Multiple Applications Supported**

Through the remote access technology, you can use the cameras to monitor various objects and places for your own purposes. For example, babies at home, patients in the hospital, office, banks, and more. The camera can capture both still images and video clips, so that you can keep the archives and restore them at any time.

## 1.4 System Requirement

### ■ Networking

LAN: 10Base-T Ethernet or 100Base-TX Fast Ethernet.  
WLAN: IEEE 802.11b/g.

### ■ Accessing the Camera using Web Browser

Platform: Microsoft® Windows® 2000/XP/Vista/Windows 7  
CPU: Intel Pentium III 800MHz or above  
RAM: 512MB  
Resolution: 800x600 or above  
User Interface: Microsoft® Internet Explorer 6.0 or above

### ■ Accessing the Camera using SecurView®

Platform: Microsoft® Windows® 2000/XP/Vista

Hardware Requirement:

1 camera connected: Intel Pentium III 800MHz; 512MB RAM  
2 ~ 4 cameras connected: Intel Pentium 4 1.3GHz; 512MB RAM  
5 ~ 8 cameras connected: Intel Pentium 4 2.4GHz; 1GB RAM  
9 ~ 16 cameras connected: Intel Pentium 4 3.4GHz; 2GB RAM  
Resolution: 1024x768 or above

**NOTE:** Monitoring multiple cameras may require a high performance CPU. To have the better performance, it recommends that you set the camera video resolution and frame rate to low level.

# CHAPTER 2

---

## HARDWARE INSTALLATION

### 2.1 Installing the Wall Mount Kit

The camera comes with a Wall Mount Kit, which allows you to place your camera anywhere by mounting the camera through the three screw holes located in the base of the Wall Mount Kit.



## 2.2 Connecting the Camera to LAN/WLAN

Use the provided Ethernet cable to connect the camera to your local area network (LAN).

When you connect the AC power adapter, the camera is powered on automatically. You can verify the power status from the Power LED on the front panel of the camera.

Once connected, the Link LED starts flashing green light and the camera is on standby and ready for use now.



Connecting the Ethernet Cable

If you use a wireless network in your application environment, you need to attach the included external antenna to the camera.

When the camera is powered on, the camera will automatically search any access point with “default” SSID.



Connecting the External Antenna

**NOTE** If the camera cannot to your wireless network, you need to install the camera in LAN and proceed with WLAN settings.

## 2.3 Applications of the Camera

The camera can be applied in multiple applications, including:

- Monitor local and remote places and objects via Internet or Intranet.
- Capture still images and video clips remotely.
- Upload images or send email messages with the still images attached.

The following diagram explains one of the typical applications for your camera and provides a basic example for installing the camera.

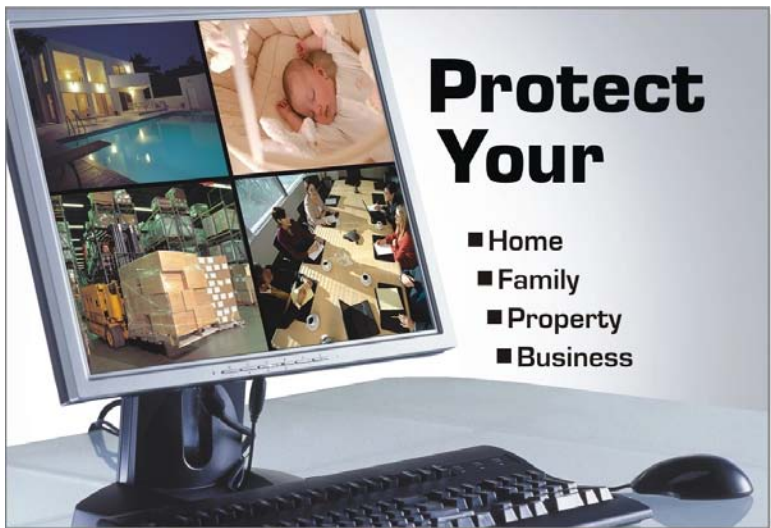

### Applications

# CHAPTER 3

---

## ACCESSING THE CAMERA

### 3.1 Using IPSetup

The camera comes with a conveniently utility, IPSetup, which is included in the Installation CD-ROM, allowing you to search the camera on your network easily.

1. Insert the Installation CD-ROM into your computer's CD-ROM drive to initiate the Auto-Run program.



2. Click the **IP Setup** from the Auto-Run menu screen. Then IP Setup Wizard will appear. Click "**Next**" when the **Welcome to the IPSetup Setup Wizard** appears.



3. Click "**Browse**" to choose the desired destination location. By default, the destination location is C:\Program Files\TRENDnet\IPSetup. Then Click "**Next**".

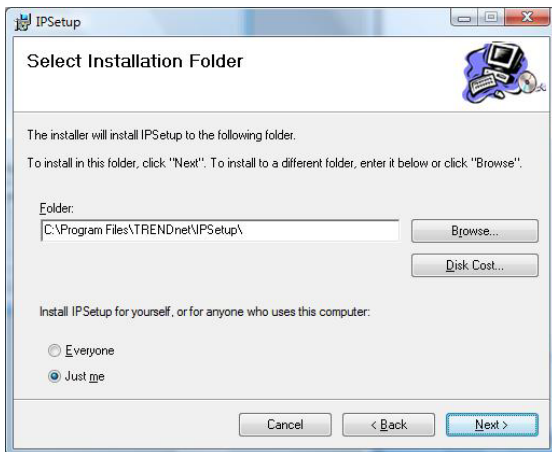

4. Click "**Next**" to confirm the IPSetup software to be installed to the computer.

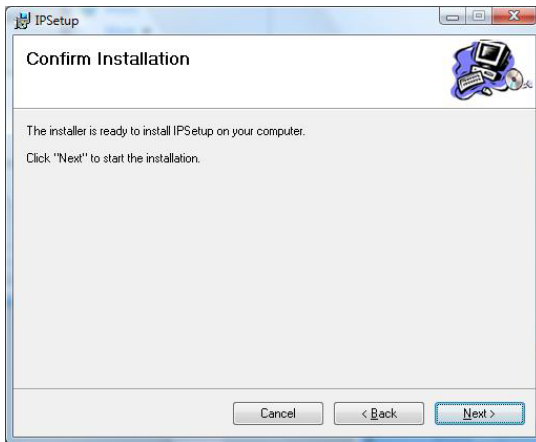

5. When the **Installation Complete** window appears, click "**Finish**".

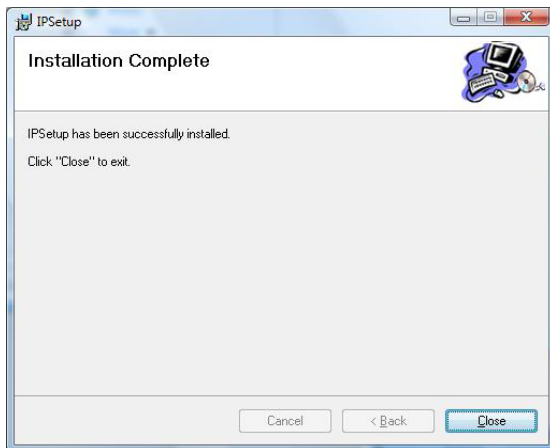



6. After installing the IPSetup utility, the application is automatically installed to your computer, and creates a folder in "**Start \Program\TRENDnet\IPSetup**".
7. Click **Start > Programs > TRENDnet > IPSetup**, and then click **IPSetup**

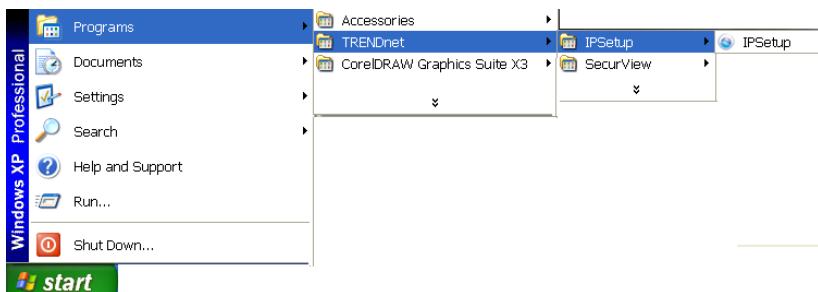

8. The IPSetup window will appear. The default IP setting is set to DHCP client. The camera's IP address will be in the same subnet as your network. If you do not have a DHCP server in your network, the IP address will default to 192.168.10.30.

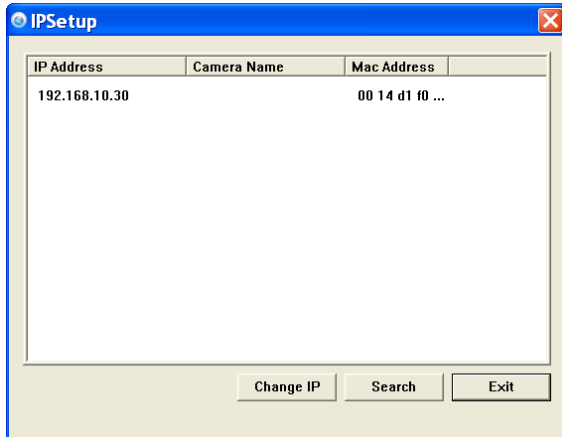

- **Camera Display Area:** It shows the connected camera(s) within the same network

Double click the IP address, it will link to Camera's Web Configuration page.

- **Change IP:** Click this button to bring up the following window. It allows you to change the IP Address. You can select either **Static IP** or click **DHCP**. Then, enter the Administrator ID & password. By default ID/password is: admin. When complete, click "**Change**".

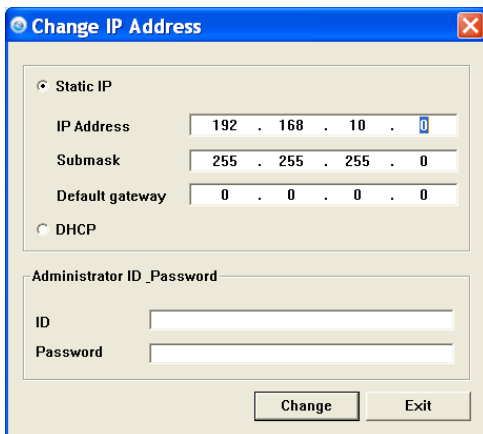

- **Search:** Click this button to search the connected camera in the same network.”
- **Exit:** Click this button to exit the program.

## 3.2 Accessing to the Camera

1. Open the Web browser on your computer (example showed in the User’s Guide is based on the Internet Explorer)
2. Type the Camera IP address in the web browser URL (e.g. 192.168.10.30) and then press [Enter].

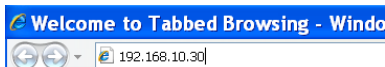

3. You can also double click on the selected camera from IPSetup which will open IE browser.

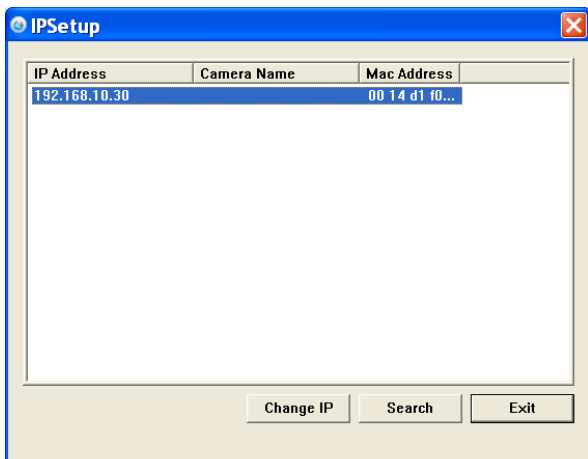

4. When the login window appears, enter the default User name (**admin**) and password (**admin**) and press **OK** to access to the main screen of the camera's Web Configuration.

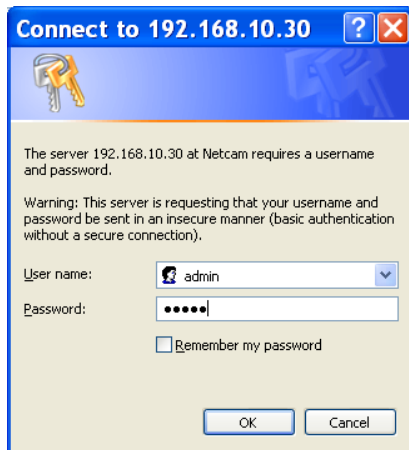

**NOTE** If you are initially access to the camera, you will be ask to install a new plug-in for the camera. Permission request depends on the Internet security settings of your computer. Click **Yes** to proceed.

After you login into the Web Configuration of the camera, the main page will appear as below:



The main page of the Web Configuration provides you with many useful information and functions, including:

- **Camera Information** – Displays the camera’s location and the current date & time. The information can be modified in the Web Configuration.
- **Live View Image** – Displays the real-time image of the connected camera.
  - Move your mouse to the Live View area and click on anywhere, the camera lens will then move to the position where you clicked to display it in the central part of Live View area.
  - When you enlarge the Live View by clicking the Zoom In buttons (2x or 3x), you can move the displayed image by right-clicking your mouse on the Live View area. The position where you right-clicked will be displayed in the central part of Live View area.
- **Zoom In Buttons** – Click the buttons to zoom in the live view image by 1x, 2x, and 3x.
- **Nightmode Buttons** – Click the nightmode buttons to increase the exposure. The frame rate will automatic adjust to half frame rate.
- **Live View/Setup Switch** – Click **Setup** to configure the camera. For details, see Chapter 4.
- **Pan/Tilt Buttons** – Provides the buttons to control the camera lens:
  - **Left/Right/Up/Down/Home** buttons allow you to move the camera lens position. Clicking the **Home** button will move the camera lens to the assigned home position.

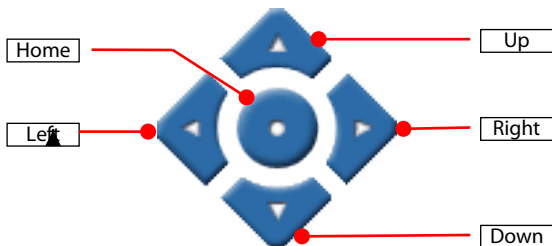

- **Auto Patrol** button controls the camera to automatically scan the preset positions once. Click **Stop** to stop patrolling.
- Click the **Number button** (1~8) to move the camera lens to the preset position immediately.

To set up the preset positions, move the camera lens by clicking the Left/Right/Up/Down buttons to the desired position first, then select the number (1~8) from the pull-down list and click the **Apply** button. You can enter a descriptive name for the assigned position in the text box to identify it easily.

- **Function Buttons** – Use these buttons to control the audio, video, and trigger functions.
  - **Manual Record** allows you to record and save a video clip.
  - **Snapshot** allows you to capture and save a still image.
  - **Browse** allows you to assign the destination folder to store the video clips and still images.
  - **Trigger Out** allows you to trigger on/off the GPIO output manually.

### 3.3 Configuring the IP Address of the PC

If you are failed to access to the camera, please check the IP address of your computer. When you connect the camera to your computer directly to proceed with configuration of the camera, you need to set up the IP addresses to be in the same segment for the two devices to communicate.

1. On your computer, click **Start > Control Panel** to open the Control Panel window.
2. Double-click **Network Connection** to open the Network Connection window.
3. Right-click **Local Area Connection** and then click **Properties** from the shortcut menu.
4. When the Local Area Connection Properties window appears, select the **General** tab.
5. Select **Internet Protocol [TCP/IP]** and then click **Properties** to bring up the Internet Protocol [TCP/IP] Properties window.
6. To configure a fixed IP address that is within the segment of the camera, select the **Use the following IP address** option. Then, enter an IP address into the empty field. The suggested IP address is **192.168.xxx.xxx** (x is 0~254, please avoid same IP address with your network devices), and the suggested Subnet mask is **255.255.255.0**.
7. When you are finished, click **OK**.



# CHAPTER 4

## CONFIGURING THE CAMERA

### 4.1 Using the Web Configuration

You can access and manage the camera through the Web browser and the provided software application SecurView. This chapter describes the Web Configuration, and guides you through the configuration of the camera by using the Web browser.

To configure the camera, click **Setup** on the main page of Web Configuration. The Web Configuration will start from the **Basic** page.

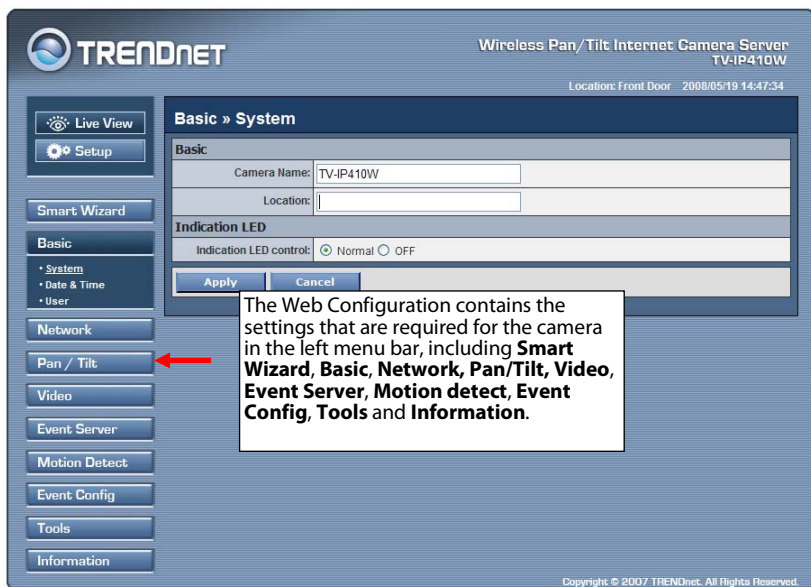

The Web Configuration contains the settings that are required for the camera in the left menu bar, including **Smart Wizard, Basic, Network, Pan/Tilt, Video, Event Server, Motion detect, Event Config, Tools and Information.**

Enter the desired camera name and location, then click **Apply**. You can also configure the camera by using the **Smart Wizard** as describe below.

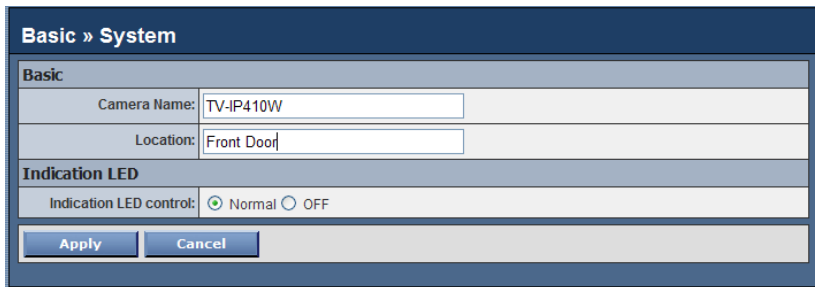

**Basic » System**

**Basic**

Camera Name:

Location:

**Indication LED**

Indication LED control:  Normal  OFF

## 4.2 Using Smart Wizard

The camera's Smart Wizard lets you configure your camera easily and quickly. The wizard will guide you through the necessary settings with detailed instructions on each step.

To start the wizard, click **Smart Wizard** in the left menu bar.



### Step 1. Camera Settings

Enter desired **Camera Name**, **Location** and **Admin Password**. By default, the password is **admin**. You can also leave the password field blank. It is highly recommend that you enter the new password. Once you have

changed to new password, please keep a record. You will need the new password to view or configure the camera later on.

**TRENDNET** Wireless Pan/Tilt Internet Camera Server  
TV-IP410W  
Location: Front Door 2008/05/19 14:48:53

**Welcome to the Smart Wizard.**  
This wizard will help you quickly set up the Network Camera to run on your network.

**Camera Settings**

Camera Name: Enter a descriptive name for the camera. For example, camera 1.

Location: Enter a descriptive name for the location used by the camera. For example, meeting room 1.

Admin Password/Confirm Password: Enter the administrator password twice to set and confirm the password to access the camera's Configuration Utility.

Camera Name: TV-IP410W  
Location: Front Door  
Admin Password: \*\*\*\*\*  
Confirm Password: \*\*\*\*\*

Next > Cancel

Copyright © 2007 TRENDnet. All Rights Reserved.

## Step 2. IP Settings

Choose **DHCP**, **Static IP** or **PPPoE**

**IP Settings**

DHCP

Static IP

IP: 192 . 168 . 10 . 30

Subnet Mask: 255 . 255 . 255 . 0

Default Gateway: 192 . 168 . 10 . 1

Primary DNS: . . . .

Secondary DNS: . . . .

PPPoE

User Name:

Password:

< Prev Next > Cancel

### Step 3. Email Settings

Enter mail server information for sending still image to email account.

Email Setting	
SMTP Server Address:	<input type="text" value="mailserver.com"/>
Sender Email Address:	<input type="text" value="joe@mailserver.com"/>
Authentication Mode:	<input type="radio"/> None <input checked="" type="radio"/> SMTP
Sender User Name:	<input type="text" value="joe"/>
Sender Password:	<input type="password" value="••••"/>
Receiver #1 Email Address:	<input type="text" value="lisa@mailserver.com"/>
Receiver #2 Email Address:	<input type="text" value="andy@mailserver.com"/>
<input data-bbox="111 557 225 581" type="button" value=" &lt; Prev "/> <input data-bbox="236 557 350 581" type="button" value=" Next &gt; "/> <input data-bbox="360 557 464 581" type="button" value=" Cancel "/>	

### Step 4. Wireless Networking

Enter wireless network information

Wireless Networking	
Network ID(SSID):	<input type="text" value="TRENDnet"/> <input data-bbox="492 777 585 800" type="button" value=" Site Survey "/>
Wireless Mode:	<input checked="" type="radio"/> Infrastructure <input type="radio"/> Ad-Hoc
Channel:	<input type="text" value="6"/>
Authentication:	<input type="text" value="Open"/>
Encryption:	<input checked="" type="radio"/> None <input type="radio"/> WEP
Format:	<input checked="" type="radio"/> ASCII <input type="radio"/> HEX
Key Length:	<input checked="" type="radio"/> 64 bits <input type="radio"/> 128 bits
<input checked="" type="radio"/> WEP Key 1	<input type="text"/>
<input type="radio"/> WEP Key 2	<input type="text"/>
<input type="radio"/> WEP Key 3	<input type="text"/>
<input type="radio"/> WEP Key 4	<input type="text"/>
<input data-bbox="111 1173 225 1197" type="button" value=" &lt; Prev "/> <input data-bbox="236 1173 350 1197" type="button" value=" Next &gt; "/> <input data-bbox="360 1173 464 1197" type="button" value=" Cancel "/>	

## Step 5. Confirm Settings

Review your setting. Click Apply to save the setting and reboot the camera. Click **<Prev** to go back to previous setting. Click **Cancel** to exiting the setting without any changes.

Confirm Settings	
Camera Name:	TV-IP410W
Location:	Front Door
IP Mode:	Static
IP Address:	192.168.10.30
Subnet Mask:	255.255.255.0
Default Gateway:	192.168.10.1
Primary DNS:	
Secondary DNS:	
SMTP Server Address:	mailserver.com
Sender Email Address:	joe@mailserver.com
Authentication Mode:	SMTP
Sender User Name:	joe@mailserver.com
Receiver #1 Email Address:	lisa@mailserver.com
Receiver #2 Email Address:	andy@mailserver.com
ESSID:	TRENDnet
Connection:	Infrastructure
Channel:	6
Authentication:	Open
Encryption:	None

## 4.3 Basic Setup

The Basic menu contains three sub-menus that provide the system settings for the camera, such as the Camera Name, Location, Date & Time, and User management.

### Basic >> System

The screenshot shows the TRENDNET web interface for a Wireless Pan/Tilt Internet Camera Server (TV-IP410W). The page title is "Basic » System". The interface includes a sidebar with navigation options: Live View, Setup, Smart Wizard, Basic (selected), System, Date & Time, User, Network, Pan / Tilt, Video, Event Server, Motion Detect, Event Config, Tools, and Information. The main content area is titled "Basic" and contains two sections: "Basic" and "Indication LED".

Basic	
Camera Name:	TV-IP410W
Location:	Front Door

Indication LED	
Indication LED control:	<input checked="" type="radio"/> Normal <input type="radio"/> OFF
<input type="button" value="Apply"/> <input type="button" value="Cancel"/>	

Copyright © 2007 TRENDnet. All Rights Reserved.

#### ■ Basic

- **Camera Name:** Enter a descriptive name for the camera.
- **Location:** Enter a descriptive name for the location used by the camera.

#### ■ Indication LED

This item allows you to set the LED illumination as desired. There are two options: **Normal** and **OFF**.

## Basic >> Date & Time

The screenshot shows the configuration interface for a TRENDNET camera. The top right corner displays 'Wireless Pan/Tilt Internet Camera Server TV-IP410W' and 'Location: Front Door 2008/05/19 09:41:41'. The left sidebar contains a 'Basic' menu with sub-items: System, Date & Time, and User. The main panel is titled 'Basic » Date & Time' and contains the following settings:

- TimeZone:** (GMT) Greenwich Mean Time : Dublin, Edinburgh, Lisbon, London
- Setting:**
  - Synchronize with PC
  - Synchronize with NTP Server
    - NTP Server Address: [Empty text box]
    - Update Interval: 6 hours
  - Manual
    - Date: 2008/05/19 (YYYY/MM/DD)
    - Time: 09:41:31 (hh:mm:ss)

Buttons for 'Apply' and 'Cancel' are located at the bottom of the settings area.

- **TimeZone:** Select the proper time zone for the region from the pull-down menu.
- **Synchronize with PC:** Select this option and the date & time settings of the camera will be synchronized with the connected computer.
- **Synchronize with NTP Server:** Select this option and the time will be synchronized with the NTP Server. You need to enter the IP address of the server and select the update interval in the following two boxes.
- **Manual:** Select this option to set the date and time manually.

## Basic >> User

Wireless Pan/Tilt Internet Camera Server  
TV-IP410W  
Location: 2007/01/01 00:03:33

**Basic >> User**

**User Accounts**

Administrator:	Password:	<input type="text"/>	
	Confirm Password:	<input type="text"/>	<input type="button" value="Modify"/>
General User:	User Name:	<input type="text"/>	
	Password:	<input type="text"/>	<input type="button" value="Add/Modify"/>
	UserList:	<input type="text"/>	<input type="button" value="Delete"/>
Guest:	User Name:	<input type="text"/>	
	Password:	<input type="text"/>	<input type="button" value="Add/Modify"/>
	UserList:	<input type="text"/>	<input type="button" value="Delete"/>
Direct Video Stream Authentication:	<input checked="" type="checkbox"/> Enable		<input type="button" value="Apply"/>

Copyright © 2009 TRENDnet. All Rights Reserved.

### ■ Administrator

To prevent unauthorized access to the camera's Web Configuration, you are strongly recommend to change the default administrator password. Type the administrator password twice to set and confirm the password.

### ■ General User

- **User Name:** Enter the user's name you want to add to use the camera.
- **Password:** Enter the password for the new user.



When you are finished, click **Add/Modify** to add the new user to the camera. To modify the user's information, select the one you want to modify from **UserList** and click **Add/Modify**.

- **UserList:** Display the existing users of the camera. To delete a user, select the one you want to delete and click **Delete**.

## ■ **Guest**

- **User Name:** Enter the guest's name you want to add to use the camera.
- **Password:** Enter the password for the new guest.
- **UserList:** Display the existing guests of the camera. To delete a user, select the one you want to delete and click **Delete**.

## ● **Direct Video Stream Authentication:**

- **Enabled** = Direct link to the video stream prompts for authentication.
- **Disable** = Direct link to video does not prompt for authentication for ease of use when implementing or embedding the video stream into a custom application or webpage.
- Examples of the Direct Link to video:

MJPEG Mode

[http://camera\\_ip\\_address:port number/jpgview.htm](http://camera_ip_address:port_number/jpgview.htm)

**NOTE** The "General User" can access the camera and control the Function buttons of the camera's Web Configuration; the "Guest" can only view the live view image from the main page of the Web Configuration while accessing the camera. Only the "Administrator" is allowed to configure the camera through the Web Configuration.

## 4.4 Network Settings

The Network menu contains three sub-menus that provide the network settings for the camera, such as the IP Setting, DDNS Setting, IP Filter, and Wireless network.

### Network >> Network

**TRENDNET** Wireless Pan/Tilt Internet Camera Server  
TV-IP410W  
Location: Front Door 2008/05/19 09:43:46

**Network » Network**

**Network**

IP Settings:

- DHCP
- Static IP

IP: 192 . 168 . 10 . 30

Subnet Mask: 255 . 255 . 255 . 0

Default Gateway: 192 . 168 . 10 . 1

Primary DNS: . . . .

Secondary DNS: . . . .

PPPoE

User Name:

Password:

DDNS Settings:

- Enable

Provider: members.dyndns.org

Host Name:

User Name:

Password:

UPnP:

- Enable

Ports Number:

HTTP Port: 80 (default: 80)

Copyright © 2007 TRENDnet. All Rights Reserved.

#### ■ IP Setting

This item allows you to select the IP address mode and set up the related configuration. The default setting is **DHCP** mode enabled.

- **DHCP:** Select this option when your network uses the DHCP server. When the camera starts up, it will be assigned an IP address from the DHCP server automatically.
- **Static IP:** Select this option to assign the IP address for the camera directly. You can use IPSetup to obtain the related setting values.

<b>IP</b>	Enter the IP address of the camera. The default setting is DHCP.
<b>Subnet Mask</b>	Enter the Subnet Mask of the camera. The default setting is <b>255.255.255.0</b> .
<b>Default Gateway</b>	Enter the Default Gateway of the camera. The default setting is <b>your router's LAN IP address</b> .
<b>Primary/ Secondary DNS</b>	DNS (Domain Name System) translates domain names into IP address. Enter the Primary DNS and Secondary DNS that are provided by ISP.

- **PPPoE:** Select this option when you use a direct connection via the ADSL modem. You should have a PPPoE account from your Internet service provider. Enter the **User Name** and **Password**. The camera will get an IP address from the ISP as starting up.

**NOTE** Once the camera get an IP address from the ISP as starting up, it automatically sends a notification email to you. Therefore, when you select PPPoE as your connecting type, you have to set up the email or DDNS configuration in advance.

## ■ DDNS Setting

With the Dynamic DNS feature, you can assign a fixed host and domain name to a dynamic Internet IP address. Select the **Enable** option to enable this feature. Then, select the Provider from the pull-down list and enter the required information in the **Host Name**, **User Name**, and **Password** boxes. Please note that you have to sign up for DDNS service with the service provider first.

## ■ UPNP

The camera supports UPnP (Universal Plug and Play), which is a set of computer network protocols that enable the device-to-device interoperability. In addition, it supports port auto mapping function so that you can access the camera if it is behind an NAT router or firewall. Select the **Enable** option to enable this feature.

## ■ Ports Number

- **HTTP Port:** The default HTTP port is **80**.

**NOTE** If the camera is behind an NAT router or firewall, the suggested port number to be used is from 1024 to 65535.

## Network >> IP Filter

The IP Filter setting allows the administrator of the camera to limit the users within a certain range of IP addresses to access the camera.

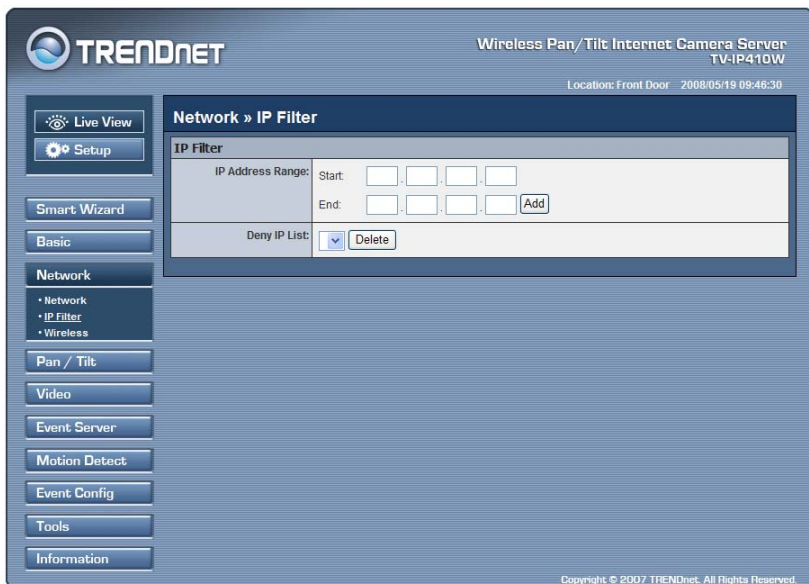

### ■ Start/End IP Address

Assign a range of IP addresses that are not allowed to access the camera by entering the Start IP address and End IP address. When you are finished, click **Add** to save the range setting. You can repeat the action to assign multiple ranges for the camera.

For example, when you enter 192.168.10.50 in Start IP Address and 192.168.10.100 in End IP Address, the user whose IP address located within 192.168.10.50 ~ 192.168.10.100 will not be allowed to access the camera.

## ■ Deny IP List

The list displays the range setting(s) of IP addresses that are not allowed to access the camera. To clear the setting, select a range of IP addresses from the list and click **Delete**.

## Network >> Wireless Setting (For TV-IP410W only)

The camera supports WLAN while you use the wireless network. Select the **Enable** option to enable this feature.

The screenshot shows the 'Network » Wireless Setting' page in the TRENDNET web interface. The page title is 'Wireless Pan/Tilt Internet Camera Server TV-IP410W' and the location is 'Front Door' with a timestamp of '2008/05/19 09:47:34'. The left sidebar contains navigation buttons: Live View, Setup, Smart Wizard, Basic, Network (selected), Pan / Tilt, Video, Event Server, Motion Detect, Event Config, Tools, and Information. The main content area is titled 'Network » Wireless Setting' and contains the following settings:

Wireless	
Enable	<input checked="" type="checkbox"/>
Network ID (SSID):	TRENDnet <input type="button" value="Site Survey"/>
Wireless Mode:	<input checked="" type="radio"/> Infrastructure <input type="radio"/> Ad-Hoc
Channel:	6
Authentication:	Open
Encryption:	<input checked="" type="radio"/> None <input type="radio"/> WEP
Format:	<input checked="" type="radio"/> ASCII <input type="radio"/> HEX
Key Length:	<input checked="" type="radio"/> 64 bits <input type="radio"/> 128 bits
WEP Key 1:	<input type="text"/>
WEP Key 2:	<input type="text"/>
WEP Key 3:	<input type="text"/>
WEP Key 4:	<input type="text"/>
<input type="button" value="Apply"/> <input type="button" value="Cancel"/>	

Copyright © 2007 TRENDnet. All Rights Reserved.

- **Network ID (SSID):** Keep the default setting of this option to connect the camera to any access point under the infrastructure network mode. To connect the camera to a specified access point, set a SSID for the camera to correspond with the access point's ESS-ID. To connect the camera to an

Ad-Hoc wireless workgroup, set the same wireless channel and SSID to match with the computer's configuration.

Click **Site Survey** to display the available wireless networks, so that you can easily connect to one of the listed wireless networks.

- **Wireless Mode:** Select the type of wireless communication for the camera: **Infrastructure** or **Ad-Hoc**.
- **Channel:** Select the appropriate channel from the list.
- **Authentication:** Select the authentication method to secure the camera from being used by unauthorized user: **Open**, **Shared-key**, **WPA-PSK**, and **WPA2-PSK**. The following table explains the four options:

<b>Open</b>	The default setting of Authentication mode, which communicates the key across the network.
<b>Shared-key</b>	Allow communication only with other devices with identical WEP settings.
<b>WPA-PSK/ WPA2-PSK</b>	WPA-PSK/WPA2-PSK is specially designed for the users who do not have access to network authentication servers. The user has to manually enter the starting password in their access point or gateway, as well as in each PC on the wireless network.

If you select **Open** or **Shared-key** as the Authentication mode, you need to complete the following settings:

**Encryption:** Select the **WEP** option to enable the data encryption feature to secure the camera within the wireless network.

**Format:** Once you enable the Encryption feature, you need to determine the encryption format by selecting **ASCII** or **HEX**. ASCII format causes each character you type to be interpreted as an eight-bit value. Hex format causes each pair of characters you

type to be interpreted as an eight-bit value in hexadecimal (base 16) notation.

**Key Length:** Select the WEP key length you use: **64 bits** or **128 bits**.

**WEP Key 1/2/3/4:** Enter the WEP key(s) in the following boxes.

If you select **WPA-PSK** or **WPA2-PSK** as the Authentication mode, you need to complete the following settings:

**Encryption:** Select **TKIP** or **AES**. TKIP (Temporal Key Integrity Protocol) changes the temporal key every 10,000 packets to insure much greater security than the standard WEP security. AES (Advanced Encryption Standard) is used to ensure the highest degree of security and authenticity for digital information.

**Pre-Shared Key:** This is used to identify each other in the network. Enter the name in the box, and this name must match the Pre-shared key value in the remote device.



## 4.5 Pan/Tilt Settings

The Pan/Tilt menu allows you to configure the pan/tilt functions of the camera.

### Pan & Tilt >> Pan & Tilt Settings

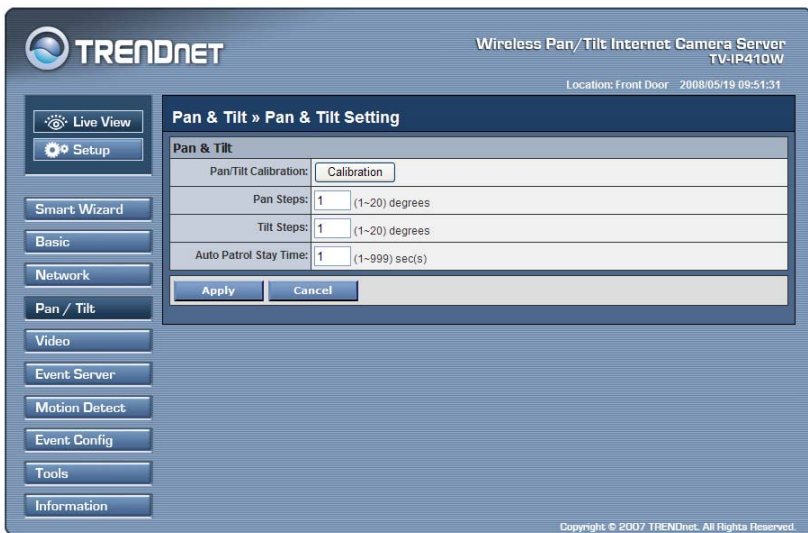

**TRENDNET** Wireless Pan/Tilt Internet Camera Server  
TV-IP410W  
Location: Front Door 2008/05/19 09:51:31

**Pan & Tilt » Pan & Tilt Setting**

**Pan & Tilt**

Pan/Tilt Calibration:	<input type="button" value="Calibration"/>
Pan Steps:	<input type="text" value="1"/> (1~20) degrees
Tilt Steps:	<input type="text" value="1"/> (1~20) degrees
Auto Patrol Stay Time:	<input type="text" value="1"/> (1~999) sec(s)

Copyright © 2007 TRENDnet. All Rights Reserved.

- **Pan/Tilt Calibration:** Click **Calibration** to calibrate the position of the camera lens.
- **Pan Steps:** Set the changing range (1~20 degrees) when you click the Left/Right button.
- **Tilt Steps:** Set the changing range (1~20 degrees) when you click the Up/Down button.
- **Auto Patrol Stay Time:** Set the stay time (1~999 seconds) of each preset positions when the camera is patrolling.

## 4.6 Setting up Video

The Video menu contains three sub-menus that provide the video settings for the camera.

### Video >> Camera

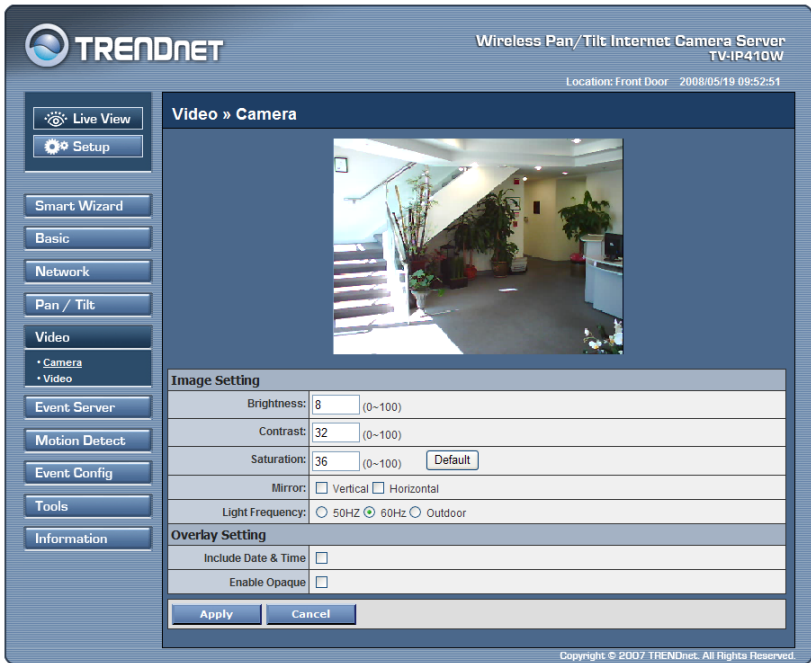

The screenshot shows the TRENDnet web interface for a Wireless Pan/Tilt Internet Camera Server (TV-IP410W). The page title is "Video » Camera". The interface includes a navigation menu on the left with options like "Live View", "Setup", "Smart Wizard", "Basic", "Network", "Pan / Tilt", "Video", "Event Server", "Motion Detect", "Event Config", "Tools", and "Information". The "Video" menu is expanded to show "Camera" and "Video". The main content area displays a live video feed of an indoor hallway. Below the video feed, there are two configuration sections: "Image Setting" and "Overlay Setting".

Image Setting	
Brightness:	8 (0~100)
Contrast:	32 (0~100)
Saturation:	36 (0~100) <input type="button" value="Default"/>
Mirror:	<input type="checkbox"/> Vertical <input type="checkbox"/> Horizontal
Light Frequency:	<input type="radio"/> 50HZ <input checked="" type="radio"/> 60Hz <input type="radio"/> Outdoor

Overlay Setting	
Include Date & Time	<input type="checkbox"/>
Enable Opaque	<input type="checkbox"/>

Copyright © 2007 TRENDnet. All Rights Reserved.

#### ■ Image Setting

- **Brightness:** Adjust the brightness level from 0 ~ 100.
- **Contrast:** Adjust the contrast level from 0 ~ 100.
- **Saturation:** Adjust the colors level from 0 ~ 100.

Click **Default** to restore the default settings of the three options above.

- **Mirror:** Select the **Horizontal** option to mirror the image horizontally. Select the **Vertical** option to mirror the image vertically.
- **Light Frequency:** Select the proper frequency according to the camera's location: **50Hz**, **60Hz**, or **Outdoor**.

#### ■ **Overlay Setting**

- **Includes Date & Time:** Select this option to display the date & time stamp on the live view image.
- **Enable Opaque:** Select this option to set a black background to the displayed date & time stamp.

## **Video >> Video**



## ■ MJPEG

- **Video Resolution:** Select the desired video resolution from the three formats: **VGA**, **QVGA** and **QQVGA**. The higher setting (VGA) obtains better video quality while it uses more resource within your network.
- **Video Quality:** Select the desired image quality from five levels: **Lowest**, **Low**, **Medium**, **High**, and **Highest**.
- **Frame Rate:** Select **Auto** or a proper setting depending on your network status.

**NOTE** The camera supports MJPEG compression. MJPEG capture the images in JPEG format, which require higher bandwidth to view smooth video. The administrator can control the bandwidth of each connection well through the setting options above.



## 4.7 Event Server Configuration

The Event Server menu contains three sub-menus that allow you to upload images to FTP, send emails that include still images, and store the images to a computer.

When you complete the required settings for FTP and Email, click **Test** to test the related configuration is correct or not. Once the camera connects to the server successfully, click **Apply**.

### Event Server Setting>> FTP



The screenshot shows the 'Event Server Setting >> FTP' configuration page. The interface includes a left sidebar with navigation buttons: Live View, Setup, Smart Wizard, Basic, Network, Pan / Tilt, Video, Event Server (selected), FTP, Email, Motion Detect, Event Config, Tools, and Information. The main content area is titled 'Event Server Setting >> FTP' and contains the following fields:

FTP	
Host Address:	60.170.180.190
Port Number:	21
User Name:	trendnet
Password:	*****
Directory Path:	/test
Passive mode:	<input checked="" type="checkbox"/> Enable

At the bottom of the configuration area are three buttons: Test, Apply, and Cancel.

Copyright © 2007 TRENDnet. All Rights Reserved.

- **Host Address:** Enter the FTP server IP address.
- **Port Number:** Enter the FTP port number.
- **User Name:** Enter the user name to login into the FTP server.

- **Password:** Enter the password to login into the FTP server.
- **Directory Path:** Enter the destination folder for uploading the images. For example, **/Test**.
- **Passive Mode:** Select the **Enable** option to enable passive mode.

## Event Server Setting >> Email

The screenshot shows the web interface for a TrendNet camera server. The main content area is titled "Event Server Setting >> Email" and contains the following configuration fields:

SMTP Server Address:	mailserver.com
Sender Email Address:	joe@mailserver.com
Authentication Mode:	<input type="radio"/> None <input checked="" type="radio"/> SMTP
Sender User Name:	joe
Sender Password:	*****
Receiver #1 Email Address:	lisa@mailserver.com
Receiver #2 Email Address:	andy@mailserver.com

At the bottom of the form are three buttons: "Test", "Apply", and "Cancel".

On the left side of the interface, there is a navigation menu with the following items: Live View, Setup, Smart Wizard, Basic, Network, Pan / Tilt, Video, Event Server (with sub-items FTP and Email), Motion Detect, Event Config, Tools, and Information.

At the top right, the interface displays: "Wireless Pan/Tilt Internet Camera Server TV-IP410W" and "Location: Front Door 2008/05/19 10:56:01".

At the bottom right, there is a copyright notice: "Copyright © 2007 TRENDnet. All Rights Reserved."

- **SMTP Server Address:** Enter the mail server address.
- **Sender Email Address:** Enter the email address of the user who will send the email.
- **Sender User Name:** Enter the user name to login the mail server.
- **Sender Password:** Enter the password to login the mail server.

- **Receiver #1 Email Address:** Enter the first email address of the user who will receive the email.
- **Receiver #2 Email Address:** Enter the second email address of the user who will receive the email.



## 4.8 Motion Detect

The Motion Detect menu contains the command and option that allow you to enable and set up the motion detection feature of the camera. The camera provides two detecting areas.

To enable the detecting area, select **Window 1** or **2** from the pull-down list, and then select **Enable**. When the detecting area is enabled, you can use the mouse to move the detecting area and change the area coverage.

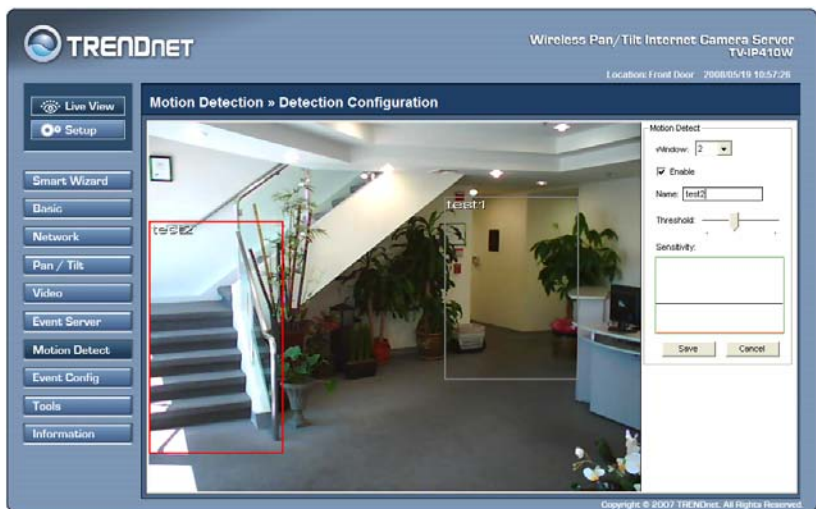

- **Name:** Assign a name to the detecting area.
- **Threshold:** Move the slide bar to adjust the level for detecting motion to record video.

**NOTE** Sliding the Threshold bar to the right will decrease the sensitivity of motion detection; sliding the Threshold bar to the left will increase the sensitivity of motion detection

## 4.9 Event Config

The Event Config menu contains five sub-menus that provide the commands to configure event profiles.

### Event Configuration >> General Setting

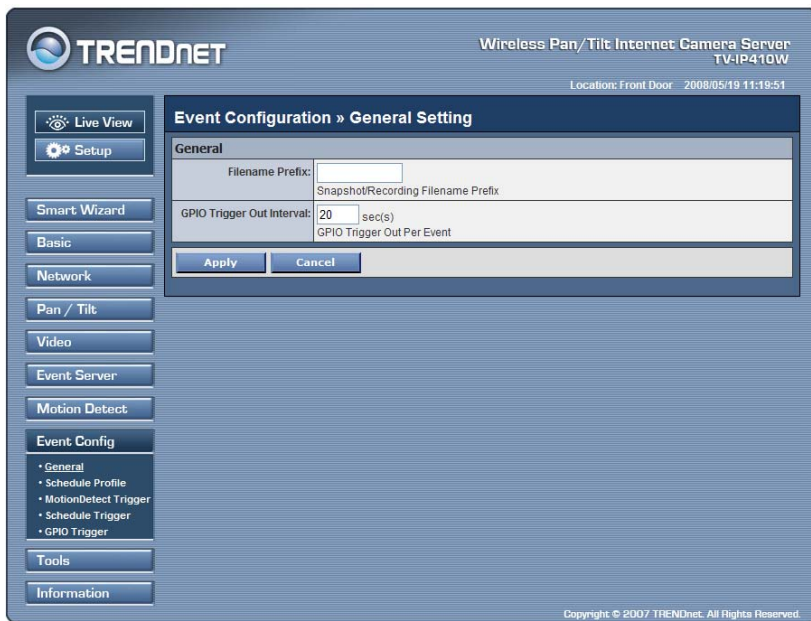

**TRENDNET** Wireless Pan/Tilt Internet Camera Server TV-IP410W  
Location: Front Door 2008/05/19 11:19:51

**Event Configuration >> General Setting**

**General**

Filename Prefix:   
Snapshot/Recording Filename Prefix

GPIO Trigger Out Interval:  sec(s)  
GPIO Trigger Out Per Event

Copyright © 2007 TRENDnet. All Rights Reserved.

- **Snapshot/Recording Subfolder:** You can assign a descriptive name for the subfolder to save the captured image/video files. Otherwise, leave this option blank to use the default setting.
- **GPIO Trigger Out Retention Time Per Event:** Limit the retention time of the GPIO Trigger Out function.

### Event Configuration >> Arrange Schedule Profile

This sub-menu displays the scheduled profile(s). To customize the profile, click **Add** and then enter a descriptive name for the profile in the prompt dialog window. Then click **OK**.

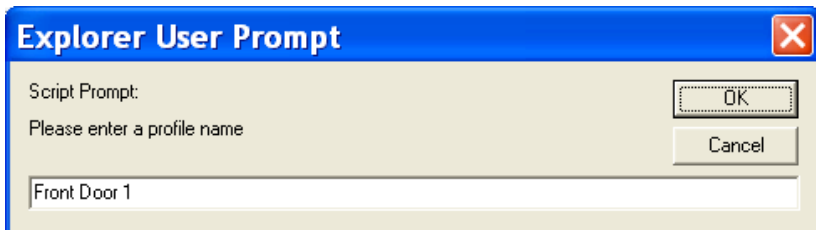

The dialog box has a blue title bar with the text "Explorer User Prompt" and a red close button. The main area is light beige and contains the following elements:

- Text: "Script Prompt:"
- Text: "Please enter a profile name"
- Text input field: "Front Door 1"
- Buttons: "OK" and "Cancel"

The profile is added to the Schedule Profiles list. To delete the profile, select the profile in the list and click **Delete**.

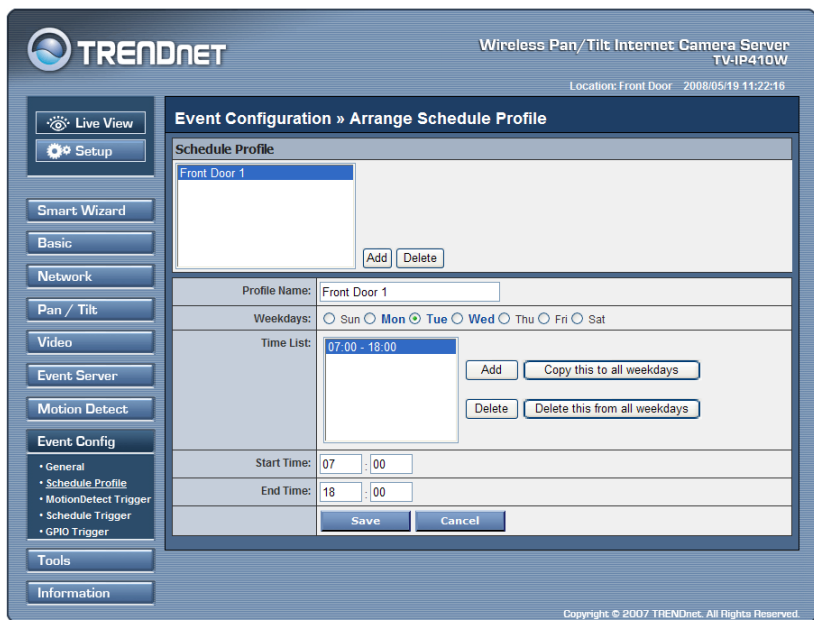

The screenshot shows the "Event Configuration » Arrange Schedule Profile" window in a web browser. The interface includes a sidebar with navigation options and a main configuration area.

**TRENDNET** Wireless Pan/Tilt Internet Camera Server TV-IP410W  
Location: Front Door 2008/05/19 11:22:16

**Event Configuration » Arrange Schedule Profile**

**Schedule Profile**

- Front Door 1 (selected)
- Buttons: Add, Delete

Profile Name: Front Door 1

Weekdays:  Sun  Mon  Tue  Wed  Thu  Fri  Sat

Time List: 07:00 - 18:00

Buttons: Add, Copy this to all weekdays, Delete, Delete this from all weekdays

Start Time: 07 : 00

End Time: 18 : 00

Buttons: Save, Cancel

Copyright © 2007 TRENDnet. All Rights Reserved.

- **Profile Name:** Display the profile name that you select in the Schedule Profiles list.
- **Weekdays:** Select the weekday(s) that you want to separately assign in the schedule profile. The weekday that has been assigned will be displayed with green color.
- **Time List:** Display the time period that you have assigned within the selected weekday. To assign the same time period to every weekday, click **Add this to all weekdays**; click **Delete this from all weekdays** to remove the selected time period from every weekday. Click Delete to remove the selected time period.
- **Start/End Time:** Enter the start and end time and then click **Add** to assign a time period within in the selected weekday.

## **Event Configuration >> Motion Detect Trigger**

Select the **Enable** option to enable the motion detect trigger function of the camera, so that you can set Trigger Out function or send captured images within the detecting area to the FTP server and email receiver. You have to configure corresponding settings, such as FTP server and email server, to enable this feature.

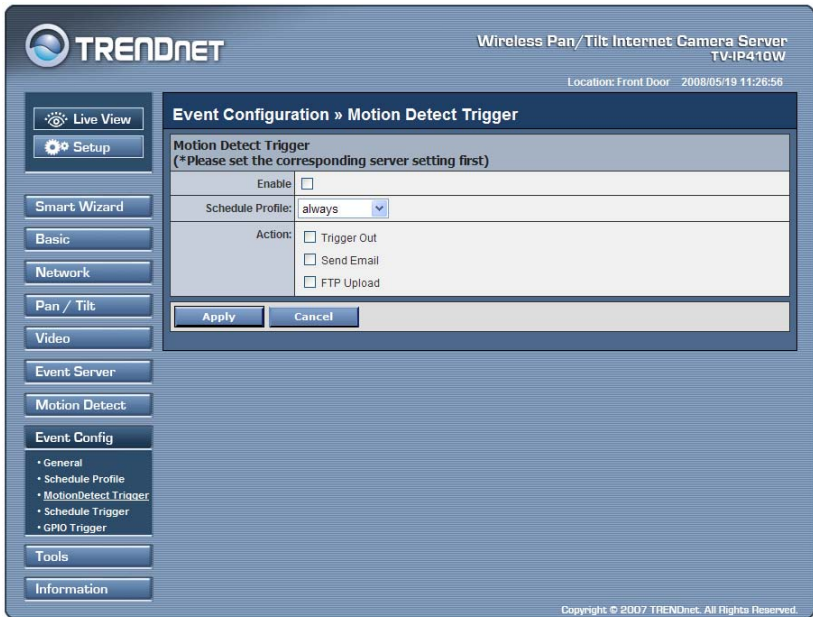

- **Schedule Profile:** Select a schedule profile from the pull-down list.

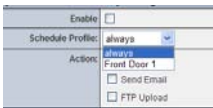

- **Action:** Set the **Trigger Out** function or select the destination of the captured images: **Send Email**, or **FTP Upload**.

**NOTE** Setting the Pre-event/Post-event time for sending email or uploading to FTP may cause the system overloads.

## Event Configuration >> Schedule Trigger

You can separately configure the schedule for trigger function of the camera by **Email** or **FTP**. Select the **Enable** option on each item, and

then select a **Schedule Profile** from the pull-down list and set the **Interval** time.

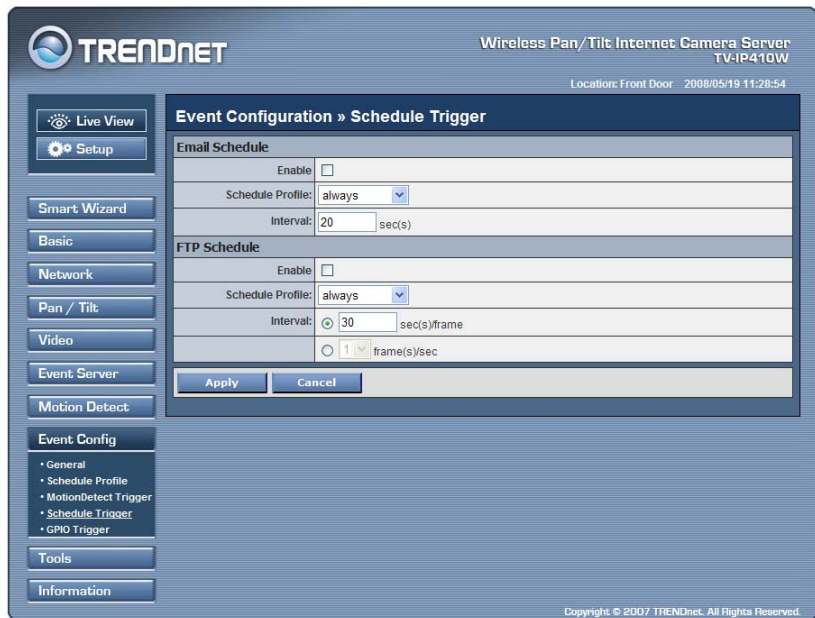

**TRENDnet** Wireless Pan/Tilt Internet Camera Server  
TV-IP410W  
Location: Front Door 2008/05/19 11:28:54

Event Configuration » Schedule Trigger

**Email Schedule**

Enable

Schedule Profile: always

Interval: 20 sec(s)

**FTP Schedule**

Enable

Schedule Profile: always

Interval: 30 sec(s)/frame

1 frame(s)/sec

Apply Cancel

Copyright © 2007 TRENDnet. All Rights Reserved.

## Event Configuration >> GPIO Trigger

Select the **Enable** option to enable the GPIO trigger function of the camera, so that you can set Trigger Out function or send captured images within the detecting area to the FTP server or email receiver,. You have to configure corresponding settings, such as FTP server and email server, to enable this feature.

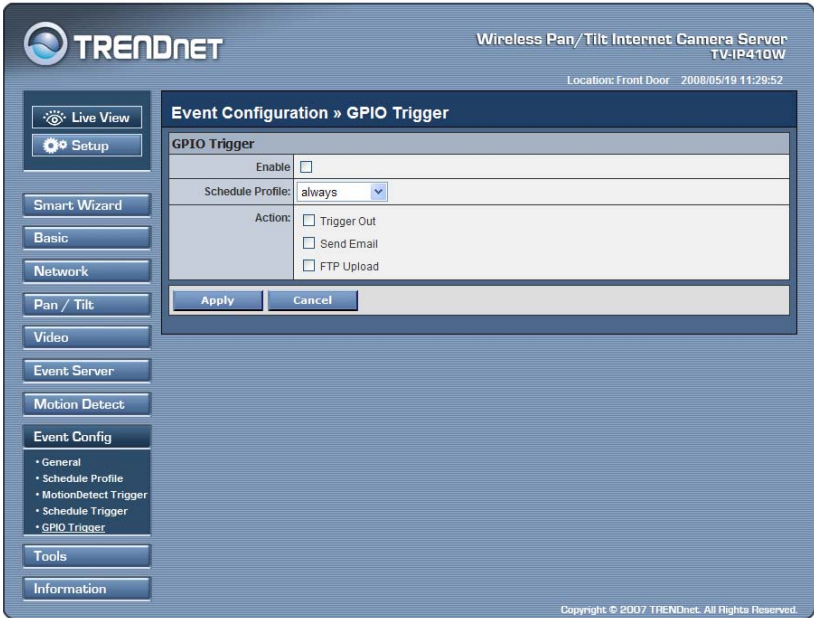

- **Schedule Profile:** Select a schedule profile from the pull-down list.
- **Action:** Set the **Trigger Out** function or select the destination of the captured images: **Send Email**, or **FTP Upload**.

**NOTE** Setting the Pre-event/Post-event time for sending email or uploading to FTP may cause the system overloads.

## 4.10 Tools

The Tools menu provides the commands that allow you to restart or reset the camera. You can also backup and restore your configuration, and upgrade the firmware for the camera.

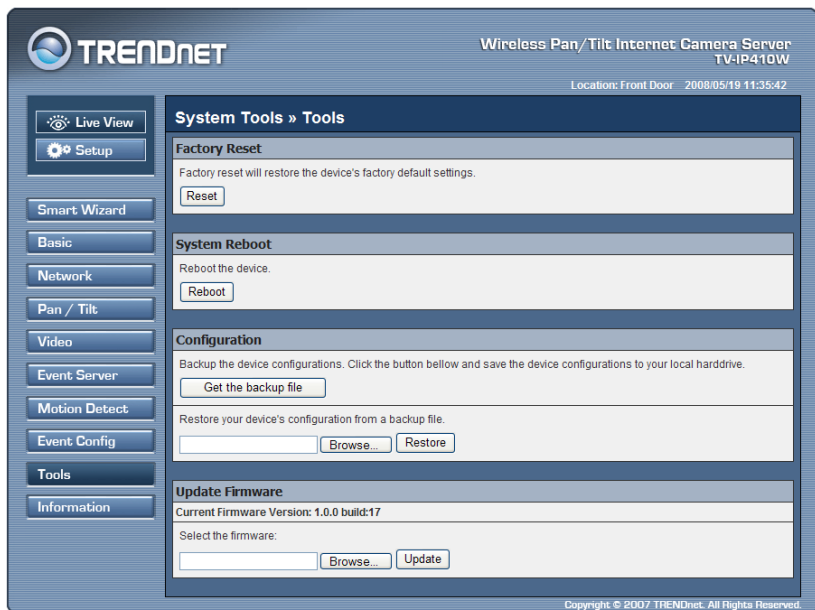

The screenshot shows the TrendNet web interface for a Wireless Pan/Tilt Internet Camera Server (TV-IP410W). The page title is "System Tools » Tools". The left sidebar contains navigation buttons: Live View, Setup, Smart Wizard, Basic, Network, Pan / Tilt, Video, Event: Server, Motion Detect, Event: Config, Tools, and Information. The main content area is divided into three sections:

- Factory Reset:** A section with the heading "Factory Reset" and the text "Factory reset will restore the device's factory default settings." Below this is a "Reset" button.
- System Reboot:** A section with the heading "System Reboot" and the text "Reboot the device." Below this is a "Reboot" button.
- Configuration:** A section with the heading "Configuration" and the text "Backup the device configurations. Click the button below and save the device configurations to your local harddrive." Below this is a "Get the backup file" button. The next section has the text "Restore your device's configuration from a backup file." and contains a text input field, a "Browse..." button, and a "Restore" button.
- Update Firmware:** A section with the heading "Update Firmware" and the text "Current Firmware Version: 1.0.0 build:17". Below this is the text "Select the firmware:" followed by a text input field, a "Browse..." button, and an "Update" button.

At the bottom right of the interface, it says "Copyright © 2007 TRENDnet. All Rights Reserved."

### ■ Factory Reset

Click **Reset** to restore all factory default settings for the camera.

### ■ System Reboot

Click **Reboot** to restart the camera just like turning the device off and on. The camera configuration will be retained after rebooting.

### ■ Configuration



You can save your camera configuration as a backup file on your computer. Whenever you want to resume the original settings, you can restore them by retrieving the backup file.

- **Backup:** Click **Get the backup file** to save the current configuration of the camera.
- **Restore:** Click **Browse** to locate the backup file and then click **Restore**.

### ■ **Update Firmware**

This item displays the current firmware version. You can upgrade the firmware for your camera once you obtained a latest version of firmware.

- **Select the firmware:** Click **Browse** to locate the backup file (.pck) and then click **Update**.

**NOTE** Make sure to keep the camera connected to the power source during the process of upgrading firmware. Otherwise, the camera might be damaged because of failure of upgrading firmware.

## 4.11 Information

The Information menu displays the current configuration and events log of the camera.

The screenshot shows the TRENDnet web interface for a Wireless Pan/Tilt Internet Camera Server (TV-IP410W). The page title is "System Information » Device Information". The interface includes a left sidebar with navigation buttons: Live View, Setup, Smart Wizard, Basic, Network, Pan / Tilt, Video, Event Server, Motion Detect, Event Config, Tools, and Information. The Information menu is expanded, showing "Device Info" and "System Log". The main content area displays configuration details for the camera, organized into sections: Basic, Video, Network, and Wireless. The location is "Front Door" and the date/time is "2008/05/19 11:41:01".

System Information » Device Information	
<b>Basic</b>	
Camera Name:	TV-IP410W
Location:	Front Door
Firmware Version:	1.0.0 build: 17
<b>Video</b>	
MJPEG Resolution:	VGA
<b>Network</b>	
IP Mode:	DHCP
IP Address:	192.168.1.169
Subnet Mask:	255.255.255.0
Default Gateway:	192.168.1.254
MAC Address:	00:1A:97:00:1A:DB
Primary DNS Address:	192.168.1.249
Secondary DNS address:	
UPnP Enable:	Enable
HTTP Port:	80
<b>Wireless</b>	
ESSID:	TRENDnet
Connection:	Infrastructure
Channel:	Not Connected
Authentication:	Open
Encryption:	None

Copyright © 2007 TRENDnet. All Rights Reserved.

### ■ Device Info

Display the Basic, Video, Network, and Wireless settings of the camera.

### ■ System Log

The Logs table displays the events log recorded by the system.

# CHAPTER 5

---

## SECURVIEW™ SOFTWARE

This Chapter describes detail instructions on operating SecurView™ software, a useful friendly application for ease of control and navigation requirement.

### 5.1 Installation

1. Insert the Installation CD-ROM into your computer's CD-ROM drive to initiate the Auto-Run program.
2. Click the **SecurView** from the Auto-Run menu screen.



**NOTE** To use SecurView™, you must have Microsoft .NET Framework 2.0 installed in the computer. The setup wizard will detect it and, if the program is not installed yet, ask you to install it during the process of installing SecurView™.

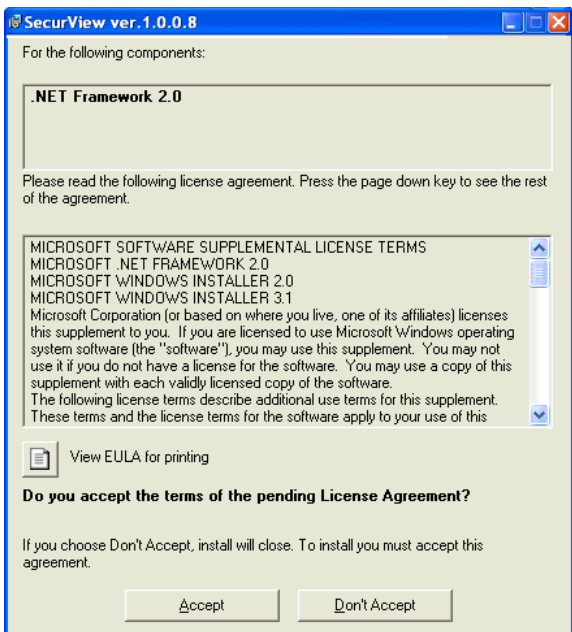

3. Then **SecurView** Setup Wizard will appear. Click "**Next**" when the **Welcome to the SecurView Setup Wizard** appears

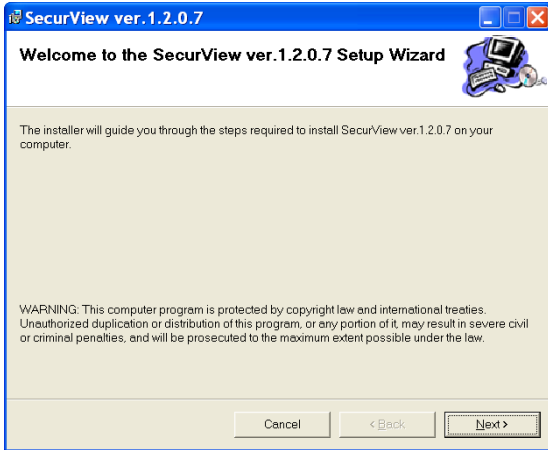

4. Click **"Browse"** to choose the desired destination location. By default, the destination location is C:\Program Files\TRENDnet\SecurView. Then Click **"Next"**.

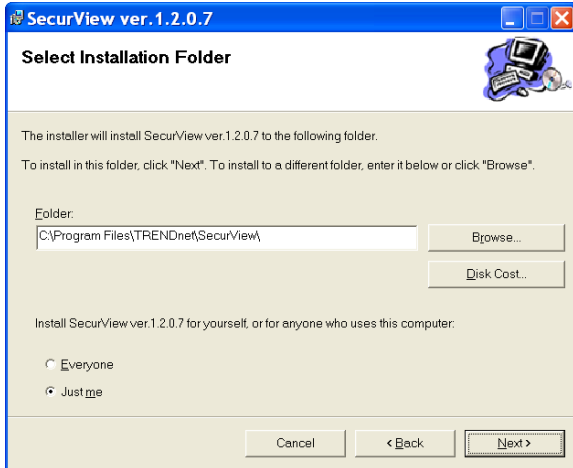

5. Click "**Next**" to confirm the SecurView software to be installed to the computer.

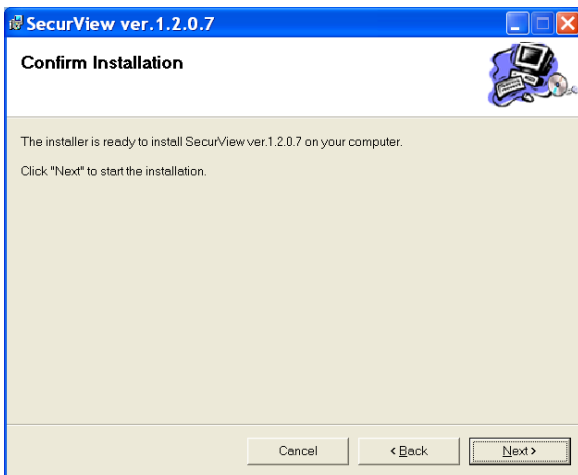

6. Click t When the **Installation Complete** window appears, click "**Close**".

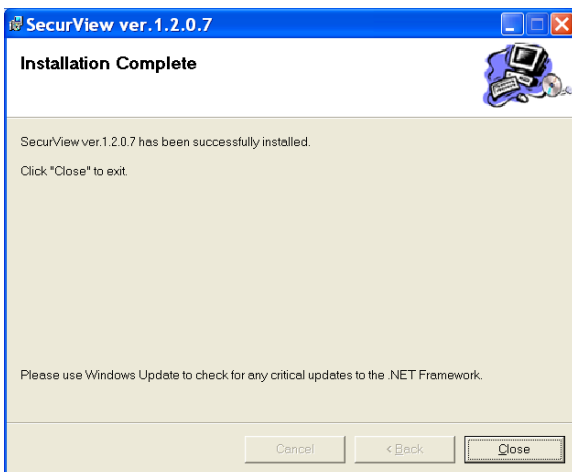

7. After installing the IPSetup utility, the application is automatically installed to your computer, and creates a folder in “ **Start** \Program\TRENDnet\SecurView”.

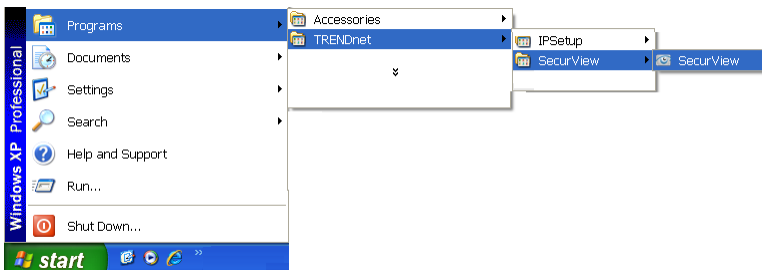

## 5.2 Using Installation

1. To launch the program, click **Start > Program > TRENDnet > SecurView**, and then click **SecruView™**. The main screen will appear as below.

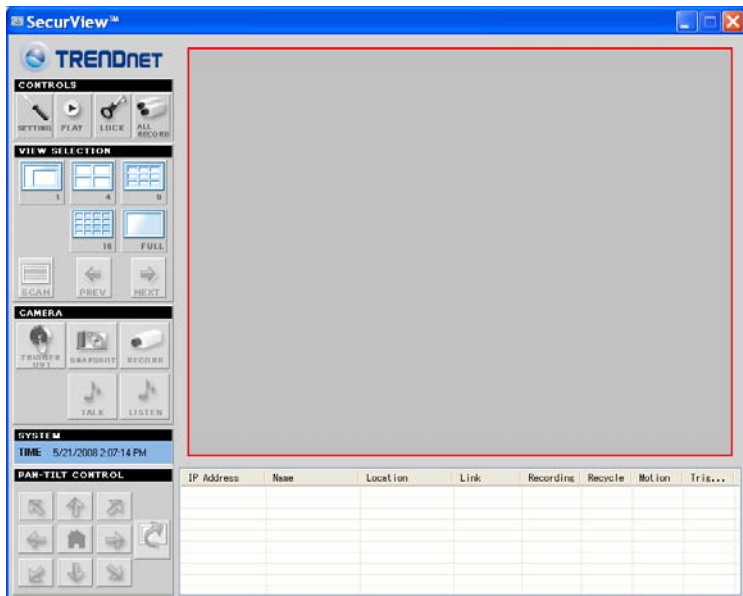

**NOTE** Please set the resolution to 1024x768 or above on your computer while using SecurView™; otherwise, the displayed main screen may be distorted.

### Item features

The following describes the function of each item on the main screen:



## ■ CONTROLS Panel



- **SETTING:** Click to enter the Setting screen of SecurView™. Click again to return to the main screen of SecurView™.
- **PLAY:** Click to play the recorded video file using the media player on the computer (for example, Windows Media Player by default).

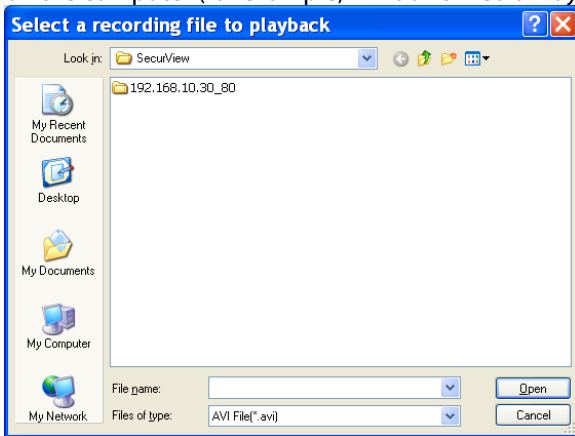

- **LOCK:** Click to lock the camera controls. Click again to resume controls for the camera. If you have set ID and Password in **SETTING > Account**, you will be asked to enter the required information to unlock.

- **ALL RECORD:** Click to start recording video clips using ALL connected cameras. To stop recording, please click Record button  to stop the individual camera. Please note: stop recording only stop the manual recording camera. For schedule recording, please change the setting on configuration.

**TIP** By default, the ID and Password boxes are “blank.” Click **SETTING** > **Account** to change the ID and password of lock/unlock function.

### ■ VIEW SELECTION Panel

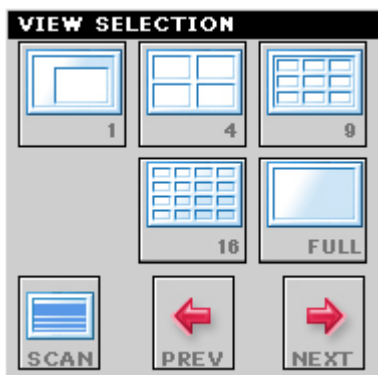

- **View mode buttons:** SecurView™ provides multiple view modes, including 1/4/9/16 windows and Full screen mode.
- **SCAN:** When multiple cameras connected, click this button to display the video views between cameras. Click the Scan button again to stop scanning.
- **PREV:** When multiple cameras connected, click this button to switch the video view to the previous camera.

- **NEXT:** When multiple cameras connected, click this button to switch the video view to the next camera.

**TIP** To set the time interval of scanning, click **SETTING > Other** and then adjust the time from 1 to 10 seconds in the **Time interval of scan** option.

## ■ CAMERA Panel



- **TRIGGER OUT:** Click to turn on the trigger out connector of the camera. This button is available only when the connected camera supports the trigger out connector, which is used to control the external device connected to the camera, such as a light.
- **SNAPSHOT:** Click to capture a still image using the selected camera and save the file in the computer.
- **RECORD:** Click to start recording a video clip using the selected camera. Click again to stop recording and save the file in the computer.
- **TALK:** Click to speak out through the camera. Please note only one user is allowed to use this function at the same time.
- **LISTEN:** Click to receive the on-site sound and voice from the camera.

## ■ SYSTEM Panel

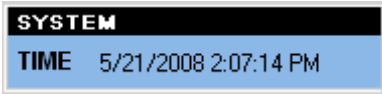

This panel displays the current date and time.

## ■ PAN-TILT CONTROL Panel

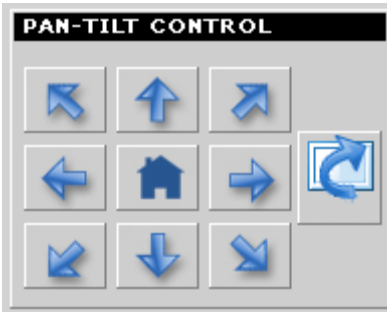

When you connect a pan/tilt camera, the system will detect the camera's function automatically and the PAN-TILT CONTROL buttons will become functional. Otherwise, these buttons are displayed as gray out buttons.

- **Direction/Home buttons:** Click these buttons to adjust the camera's viewing angle to Up (↑) / Down (↓) / Left (←) / Right (→) / Left-Up (↖) / Left-Down (↙) / Right-Up (↗) / Right-Down (↘).

Click the **Home** button (🏠) to return the camera to the default position.

- **SWING:** If you have saved two or more positions for the selected camera, click the **Swing** button (  ) to control the camera swinging from one position to another position.

## ■ Video View Window and Camera List

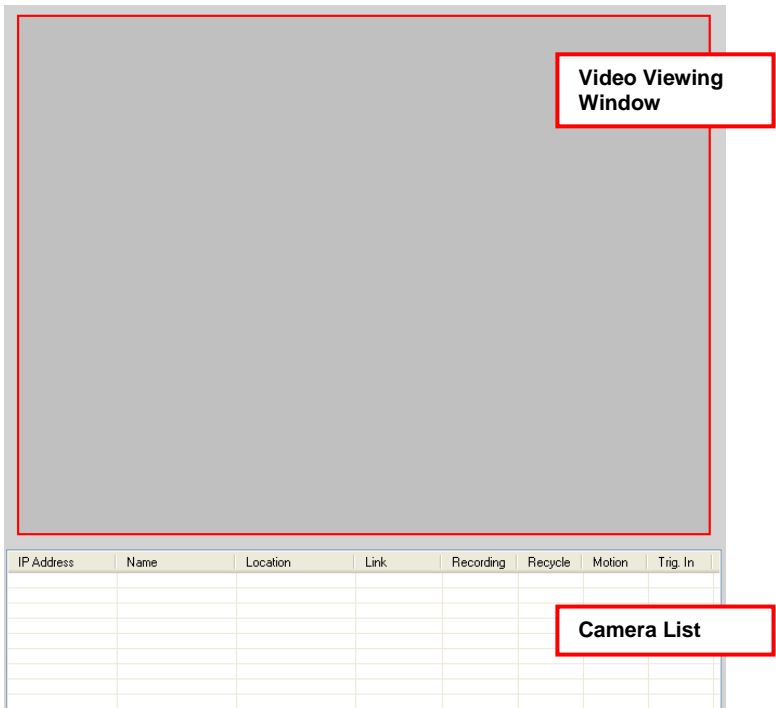

- **Video Viewing Window:** This window displays the video view of the selected camera, which can be divided into 4/9/16 windows according to your selection in VIEW SELECTION panel.
- **Camera List:** This list displays the information of the connected camera(s).



3. In the pop-up Add New Camera dialog window, you can:
- Select the **Search** tab if you are not sure of the camera's IP address. Click **Search camera** to search the available camera within the network. Once the camera is found and is shown in the list, select it and click **Add Camera**.

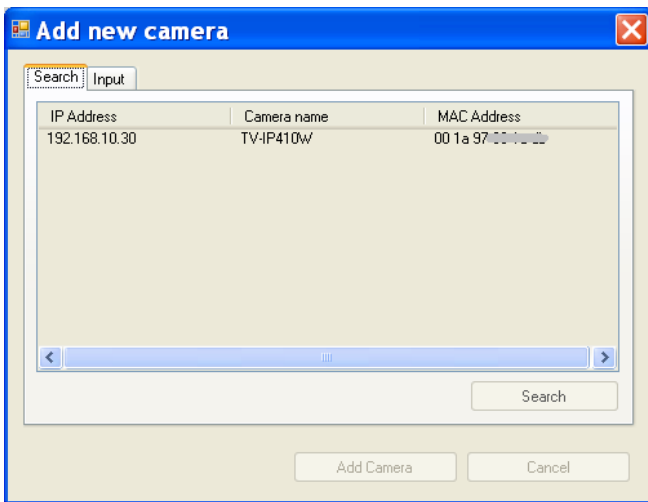

- Select the **Input** tab to add a camera by entering its IP address directly. Enter the camera's IP address and Port default: **80**), and then click **Add Camera**.

**Add new camera**

Search Input

IP Address:  
192.168.10.30

Port:  
80

Add Camera Cancel

4. Enter the User name and Password for the camera, and then click **OK**. The connected camera will be displayed in the Camera List.

**Login**

UserName  
admin

Password  
xxxxxx

OK Cancel



- Click **SETTING** to return to the Video View Window. The video view of the selected camera will be displayed now.

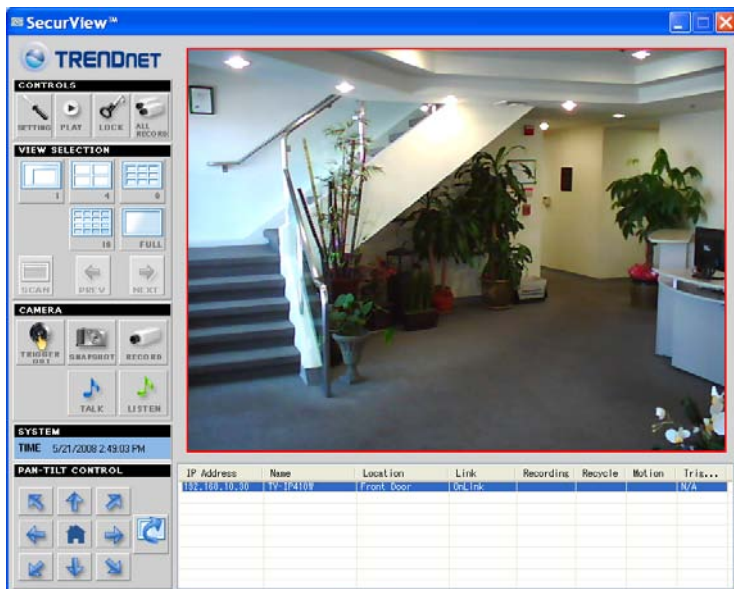

## To remove a camera

- Click **SETTING** in the CONTROLS panel to display the Setting screen.
- Select a camera from the list and click **Delete Camera**.

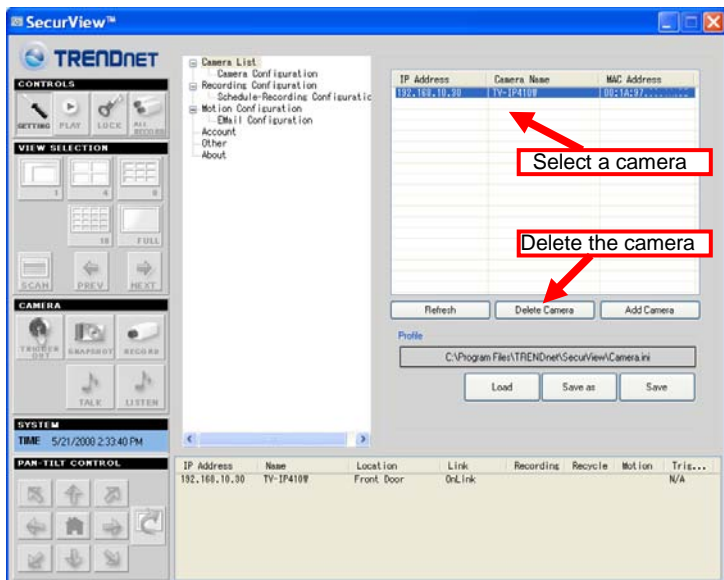

## To link to the Web page of the camera

Click **SETTING > Camera List > Camera Configuration** and then **Link web page** to launch the Web browser that displays live view image and Web Configuration of the selected camera.



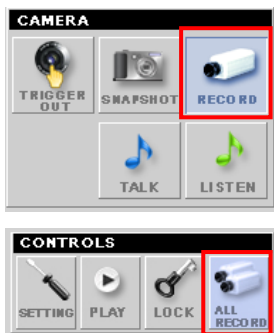

- **Trigger recording by motion detection**

When the motion detection function of the selected camera is enabled, you can configure the camera to start recording triggered by the motion detected. Click **SETTING > Motion Configuration**, and then select the **Recording** option to enable the selected camera to record by motion detection.

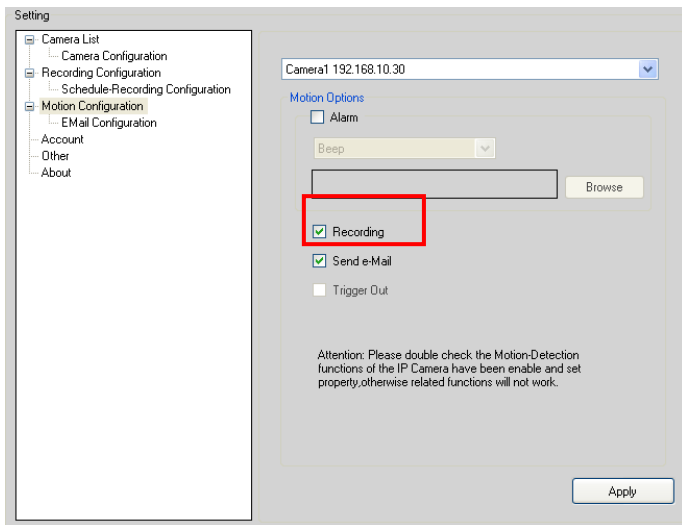

- **Schedule recording Configuration**

This recording method will work after you have completed the required settings in **Schedule Recording Configuration**. The recording schedule can be defined by **Dates** or **Days**.

- **Dates:** Select the camera from the pull-down list..

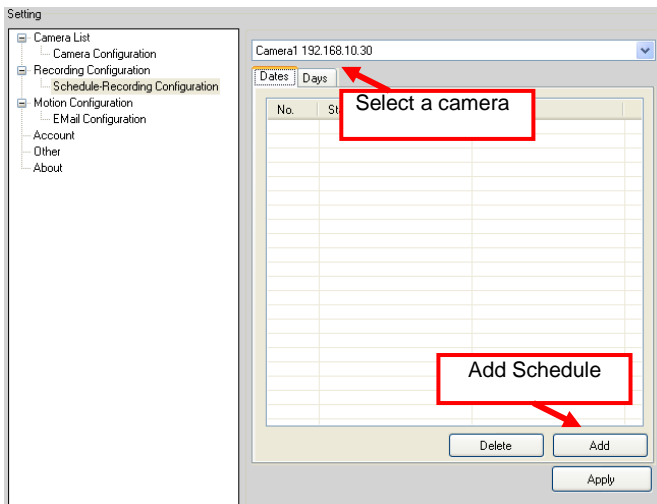

- Then, click **Add** to set the Start/Stop date and time and then click **OK** to add the recording schedule to the list.

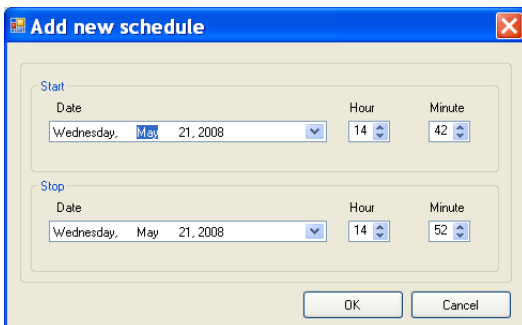

- Click **Apply** to save the settings



**Days:** First, select the camera from the pull-down list and select **Days** tab. Then, select the weekday from the day buttons and then set the time period. Click **Apply** to save the settings.

The screenshot shows a configuration window for 'Camera1 192.168.10.30 TV-IP410W'. The 'Days' tab is active, and the 'Tue' button is selected. A grid of checkboxes allows selecting time periods for recording. The following table represents the visible options in the grid:

Time Period	Selected
00:00-00:30	<input type="checkbox"/>
00:30-01:00	<input type="checkbox"/>
01:00-01:30	<input type="checkbox"/>
01:30-02:00	<input type="checkbox"/>
02:00-02:30	<input checked="" type="checkbox"/>
02:30-03:00	<input checked="" type="checkbox"/>
03:00-03:30	<input type="checkbox"/>
03:30-04:00	<input type="checkbox"/>
04:00-04:30	<input checked="" type="checkbox"/>
04:30-05:00	<input checked="" type="checkbox"/>
05:00-05:30	<input checked="" type="checkbox"/>
05:30-06:00	<input checked="" type="checkbox"/>
06:00-06:30	<input type="checkbox"/>
06:30-07:00	<input type="checkbox"/>
07:00-07:30	<input type="checkbox"/>
07:30-08:00	<input type="checkbox"/>
08:00-08:30	<input type="checkbox"/>
08:30-09:00	<input type="checkbox"/>
09:00-09:30	<input checked="" type="checkbox"/>
09:30-10:00	<input checked="" type="checkbox"/>
10:00-10:30	<input checked="" type="checkbox"/>
10:30-11:00	<input checked="" type="checkbox"/>
11:00-11:30	<input checked="" type="checkbox"/>
11:30-12:00	<input checked="" type="checkbox"/>
12:00-12:30	<input checked="" type="checkbox"/>
12:30-13:00	<input checked="" type="checkbox"/>
13:00-13:30	<input checked="" type="checkbox"/>
14:30-15:00	<input type="checkbox"/>
15:00-15:30	<input type="checkbox"/>
15:30-16:00	<input type="checkbox"/>
16:00-16:30	<input type="checkbox"/>
16:30-17:00	<input type="checkbox"/>
17:00-17:30	<input type="checkbox"/>
17:30-18:00	<input type="checkbox"/>
18:00-18:30	<input type="checkbox"/>
18:30-19:00	<input type="checkbox"/>
19:00-19:30	<input type="checkbox"/>
19:30-20:00	<input type="checkbox"/>
20:00-20:30	<input type="checkbox"/>
20:30-21:00	<input type="checkbox"/>
21:00-21:30	<input type="checkbox"/>
21:30-22:00	<input type="checkbox"/>
22:00-22:30	<input type="checkbox"/>
22:30-23:00	<input type="checkbox"/>
23:00-23:30	<input type="checkbox"/>
23:30-00:00	<input type="checkbox"/>

At the bottom of the window, there are buttons for 'Fetch Template', 'Paste Template', 'Clear', and 'Apply'.

## To configure the recording settings

To configure the recording settings, including the storage folder and storage options, click **SETTING > Recording Configuration**.



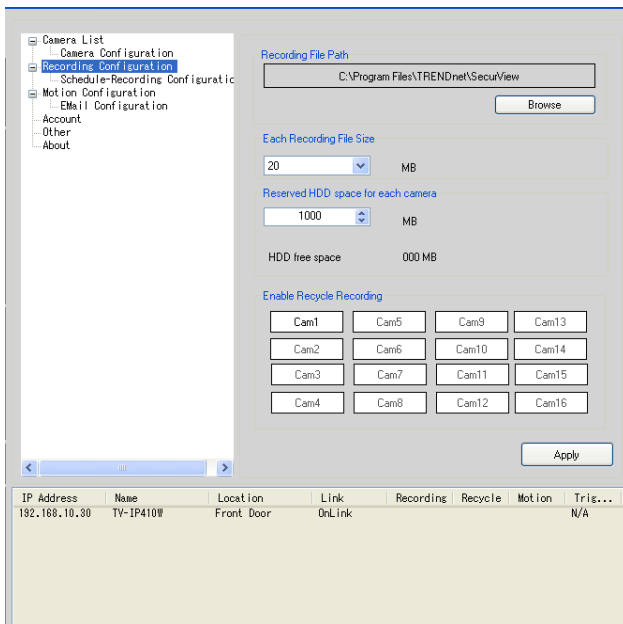

- **Recording File Path:** To change the destination folder to save the recorded video file, click **Browse** under the **Recording File Path** box to assign a new folder.
- **Each Recording File Size:** This option allows you to select from **20** to **100** MB so that the video will be recorded as another file automatically when the recording file reaches the specified size limit.
- **Reserved HDD space for each camera:** This option allows you to set to reserve the storage space on the hard disk drive for the recording of each camera. Before setting the reserve space on the

hard disk drive, you can check the available storage space that is displayed in the **HDD Free space** field.

- **Enable Recycle Recording:** Click on the camera number to clear the files when the unreserved space of the hard disk drive is full.

## To playback the recorded video

The recorded video clips are saved in your computer, and can be played using the media player on the computer, such as Windows Media Player. To start playback, simply click the **PLAY** button on the CONTROLS panel, and the following dialog screen will appear, allowing you to select the file to playback.

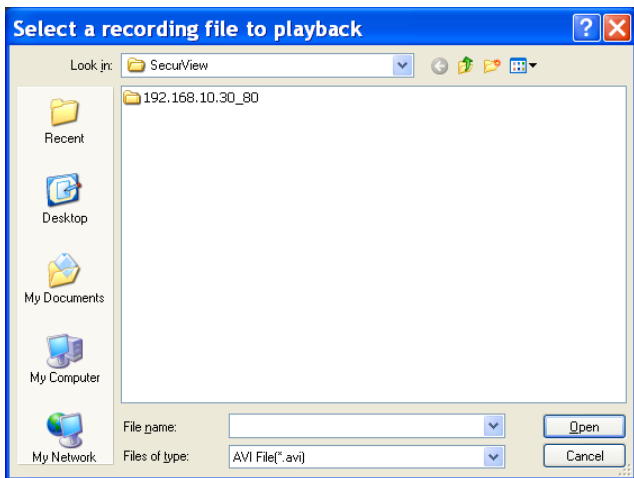

Select the recorded video file under the [camera] path and then click **Open** to launch the media player to playback.

**NOTE** If your player on the computer don't have video codec to playback the recorded video. You can download video codec from <http://www.xvid.org/downloads.15.0.html> to support.

## To set up motion detection options

When the motion detection function of the selected camera is enabled, you can set the **Motion Options** by selecting **Alarm**, **Recording**, **Send e-Mail**, and **Trigger Out** under **SETTING > Motion Configuration**.

The screenshot shows a web-based configuration interface for a camera. At the top, a dropdown menu displays 'Camera1 192.168.10.30 TV-IP410W'. Below this, the 'Motion Options' section is titled in blue. It contains several settings: 'Alarm' is checked, with a dropdown menu open showing 'Beep' (selected), 'Beep', and 'Music'. A 'Browse' button is to the right of this dropdown. 'Recording' is checked. 'Send e-Mail' is checked. 'Trigger Out' is unchecked, with a dropdown menu set to '20' and the unit 'Sec'. At the bottom, there is an 'Apply' button. A note at the bottom of the configuration area reads: 'Attention: Please double check the Motion-Detection functions of the IP Camera have been enable and set property, otherwise related functions will not work.'

- **Alarm:** Select **Beep** or **Music** to alert you for the motion detected. When you select **Music**, you can customize the sound by clicking

**Browse** and then selecting your favorite music (\*.wav or \*.mp3 file) in the computer.

- **Recording:** Select this option to enable the camera to record by motion detected.
- **Send Email:** Select this option so that the system will be able to send an email to the specified receiver. Once the option is selected, you have to complete the required information in **SETTING > Motion Configuration > Email Configuration.**

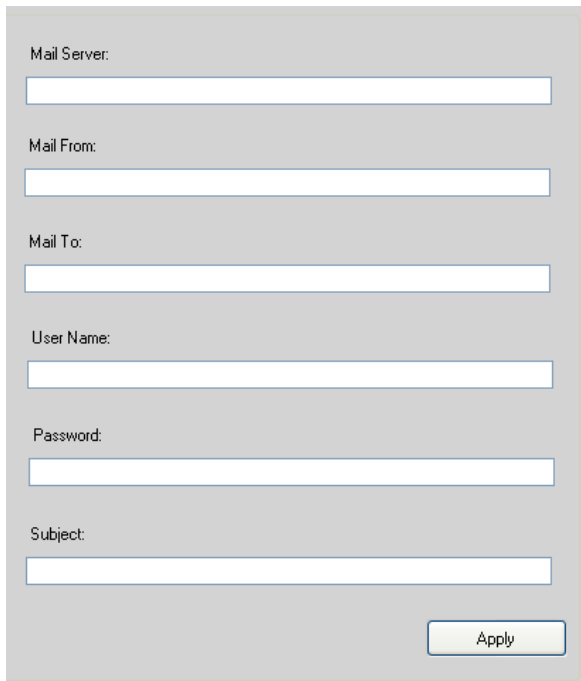

Mail Server:

Mail From:

Mail To:

User Name:

Password:

Subject:

Apply

- **Mail Server:** Enter the mail server address. For example, [myemail.com](mailto:myemail.com).

- **Mail From:** Enter the email address of the user who will send the email. For example, [John@mymail.com](mailto:John@mymail.com).
- **Mail To:** Enter the email address of the user who will receive the email.
- **User Name:** Enter the user name to login the mail server.
- **Password:** Enter the password to login the mail server.
- **Subject:** Enter a subject for the notification email.
- **Trigger Out:** If the selected camera supports Trigger Out connector, select this option to enable the Trigger Out function.

## Account

Click **SETTING > Account** to setup the username & password to lock & unlock the main screen of the SecurView.

## Other

Click **SETTING > Other** to setup the scanning time between cameras. The default setting is 2 seconds. You can set the interval time between 2 ~ 20 seconds.

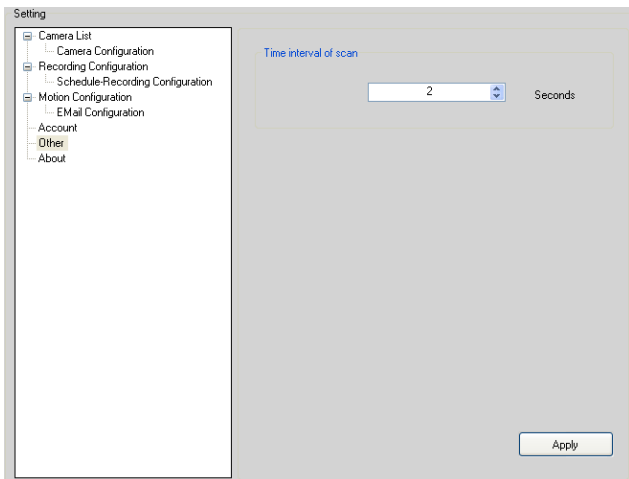

## Information

Click **SETTING** > **About** to display the information of the software application.

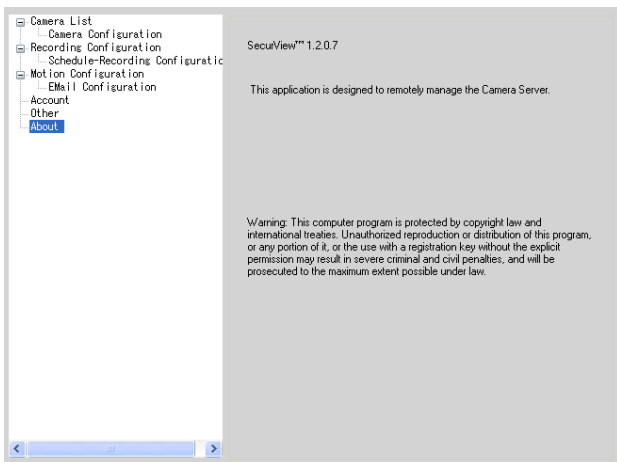

# APPENDIX

---

## A.1 Specification

### ■ Image Sensor

<b>Sensor</b>	1/4" color CMOS
<b>Resolution</b>	640x480

### ■ Video

<b>Compression</b>	MJPEG
<b>Video resolution</b>	VGA/QVGA/QQVGA; 30fps max.

### ■ User Interface

<b>LAN</b>	One RJ-45 port
<b>Antenna</b>	One external antenna
<b>Reset</b>	One Reset button
<b>GPIO</b>	1 in/1 out connectors Input: active high: 9~40V DC; dropout: 0V DC Output: close circuit current 70mA AC or 100mA DC maximum, 30 Ohm; open circuit voltage 240V AC or 350V DC maximum
<b>LEDs</b>	Power LED (orange); Link LED (green)

### ■ System Hardware

<b>Processor</b>	ARM9 base
<b>RAM</b>	32MB SDRAM
<b>ROM</b>	8MB NOR Flash
<b>Power</b>	DC 12V, 1.5A



## ■ **Communication**

**LAN** 10/100Mbps Fast Ethernet, auto-sensed, Auto-MDIX

**WLAN** IEEE 802.11b/g

**Protocol support** TCP/IP, UDP, ICMP, DHCP, NTP, DNS, DDNS, SMTP, FTP, PPPoE, UPnP

## ■ **Pan/Tilt**

**Pan** 165 degree (left) to 165 degree (right)

**Tilt** 90 degree (up) to 15 degree (down)

## ■ **Software**

**OS Support** Windows 2000/XP/Vista

**Browser** Internet Explorer 6.0 or above

**Software** SecurView for playback/recording/  
configuration features

## ■ **Operating Environment**

**Temperature** - Operation: 0°C ~ 45°C

- Storage: -15°C ~ 60°C

**Humidity** - Operation: 20% ~ 85% non-condensing

- Storage: 0% ~ 90% non-condensing

## ■ **EMI**

FCC Class B, CE Class B

## A.2 GPIO Terminal Application

Typically used in association with programming scripts for developing applications for motion detection, event triggering, alarm notification via e-mail, and a variety of external control functions. The GPIO connectors are located on the rear panel of the camera, which provide the interface of connecting the sensor device (IN) and controlled device (OUT).

### Connector Pin Assignment

PIN	SPECIFICATION
IN	Active High voltage 9~40V DC; Dropout-out voltage 0V DC
OUT	Close circuit current 70mA AC or 100mA DC maximum, Output resistance 30 Ohm; Open circuit voltage 240V AC or 350V DC maximum

### Interface Schematic

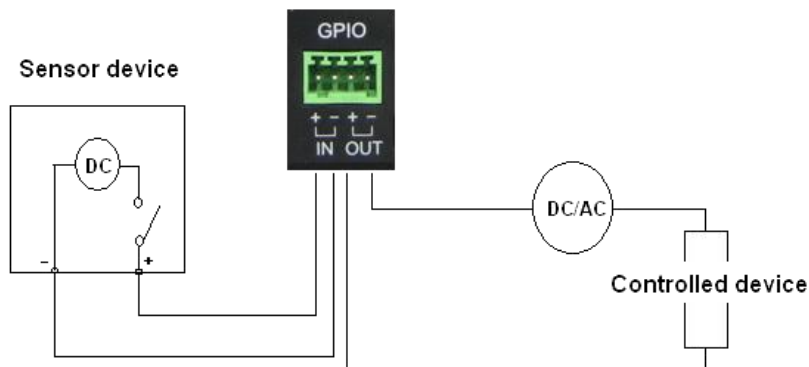

## A.3 Glossary of Terms

### NUMBERS

- 10BASE-T** 10BASE-T is Ethernet over UTP Category III, IV, or V unshielded twisted-pair media.
- 100BASE-TX** The two-pair twisted-media implementation of 100BASE-T is called 100BASE-TX.

### A

- ADPCM** Adaptive Differential Pulse Code Modulation, a new technology improved from PCM, which encodes analog sounds to digital form.
- Applet** Applets are small Java programs that can be embedded in an HTML page. The rule at the moment is that an applet can only make an Internet connection to the computer from that the applet was sent.
- ASCII** American Standard Code For Information Interchange, it is the standard method for encoding characters as 8-bit sequences of binary numbers, allowing a maximum of 256 characters.
- ARP** Address Resolution Protocol. ARP is a protocol that resides at the TCP/IP Internet layer that delivers data on the same network by translating an IP address to a physical address.
- AVI** Audio Video Interleave, it is a Windows platform audio and video file type, a common format for small movies and videos.

### B

- BOOTP** Bootstrap Protocol is an Internet protocol that can automatically configure a network device in a diskless workstation to give its own IP address.

### C

**Communication** Communication has four components: sender, receiver, message, and medium. In networks, devices and application tasks and processes communicate messages to each other over media. They represent the sender and receivers. The data they send is the message. The cabling or transmission method they use is the medium.

**Connection** In networking, two devices establish a connection to communicate with each other.

## D

### **DHCP**

Developed by Microsoft, DHCP (Dynamic Host Configuration Protocol) is a protocol for assigning dynamic IP addresses to devices on a network. With dynamic addressing, a device can have a different IP address every time it connects to the network. In some systems, the device's IP address can even change while it is still connected. It also supports a mix of static and dynamic IP addresses. This simplifies the task for network administrators because the software keeps track of IP addresses rather than requiring an administrator to manage the task. A new computer can be added to a network without the hassle of manually assigning it a unique IP address. DHCP allows the specification for the service provided by a router, gateway, or other network device that automatically assigns an IP address to any device that requests one.

### **DNS**

Domain Name System is an Internet service that translates domain names into IP addresses. Since domain names are alphabetic, they're easier to remember. The Internet however, is really based on IP addresses every time you use a domain name the DNS will translate the name into the corresponding IP address. For example, the domain name *www.network\_camera.com* might translate to *192.167.222.8*.

## E

### **Enterprise**

An enterprise network consists of collections of networks connected to each other over a geographically dispersed

**network** area. The enterprise network serves the needs of a widely distributed company and operates the company's mission-critical applications.

**Ethernet** The most popular LAN communication technology. There are a variety of types of Ethernet, including 10Mbps (traditional Ethernet), 100Mbps (Fast Ethernet), and 1,000Mbps (Gigabit Ethernet). Most Ethernet networks use Category 5 cabling to carry information, in the form of electrical signals, between devices. Ethernet is an implementation of CSMA/CD that operates in a bus or star topology.

## **F**

**Fast Ethernet** Fast Ethernet, also called 100BASE-T, operates at 10 or 100Mbps per second over UTP, STP, or fiber-optic media.

**Firewall** Firewall is considered the first line of defense in protecting private information. For better security, data can be encrypted. A system designed to prevent unauthorized access to or from a private network. Firewalls are frequently used to prevent unauthorized Internet users from accessing private networks connected to the Internet, especially Intranets all messages entering or leaving the intranet pass through the firewall, which examines each message and blocks those that do not meet the specified security criteria.

## **G**

**Gateway** A gateway links computers that use different data formats together.

**Group** Groups consist of several user machines that have similar characteristics such as being in the same department.

## **H**

**HEX** Short for hexadecimal refers to the base-16 number system, which consists of 16 unique symbols: the numbers 0 to 9 and the letters A to F. For example, the decimal number 15 is

represented as F in the hexadecimal numbering system. The hexadecimal system is useful because it can represent every byte (8 bits) as two consecutive hexadecimal digits. It is easier for humans to read hexadecimal numbers than binary numbers.

## I

### **Intranet**

This is a private network, inside an organization or company that uses the same software you will find on the public Internet. The only difference is that an Intranet is used for internal usage only.

### **Internet**

The Internet is a globally linked system of computers that are logically connected based on the Internet Protocol (IP). The Internet provides different ways to access private and public information worldwide.

### **Internet address**

To participate in Internet communications and on Internet Protocol-based networks, a node must have an Internet address that identifies it to the other nodes. All Internet addresses are IP addresses

### **IP**

Internet Protocol is the standard that describes the layout of the basic unit of information on the Internet (the *packet*) and also details the numerical addressing format used to route the information. Your Internet service provider controls the IP address of any device it connects to the Internet. The IP addresses in your network must conform to IP addressing rules. In smaller LANs, most people will allow the DHCP function of a router or gateway to assign the IP addresses on internal networks.

### **IP address**

IP address is a 32-binary digit number that identifies each sender or receiver of information that is sent in packets across the Internet. For example 80.80.80.69 is an IP address. When you “call” that number, using any connection methods, you get connected to the computer that “owns” that IP address.

### **ISP**

ISP (Internet Service Provider) is a company that maintains a network that is linked to the Internet by way of a dedicated

communication line. An ISP offers the use of its dedicated communication lines to companies or individuals who can't afford the high monthly cost for a direct connection.

## J

### **JAVA**

Java is a programming language that is specially designed for writing programs that can be safely downloaded to your computer through the Internet without the fear of viruses. It is an object-oriented multi-thread programming best for creating applets and applications for the Internet, Intranet and other complex, distributed network.

## L

### **LAN**

Local Area Network a computer network that spans a relatively small area sharing common resources. Most LANs are confined to a single building or group of buildings.

## M

### **MJPEG**

MJPEG (Motion JPEG) composes a moving image by storing each frame of a moving picture sequence in JPEG compression, and then decompressing and displaying each frame at rapid speed to show the moving picture.

## N

### **NAT**

Network Address Translator generally applied by a router that makes many different IP addresses on an internal network appear to the Internet as a single address. For routing messages properly within your network, each device requires a unique IP address. But the addresses may not be valid outside your network. NAT solves the problem. When devices within your network request information from the Internet, the requests are forwarded to the Internet under the router's IP address. NAT distributes the responses to the proper IP addresses within your network.

## **Network**

A network consists of a collection of two or more devices, people, or components that communicate with each other over physical or virtual media. The most common types of network are:

**LAN** – (local area network): Computers are in close distance to one another. They are usually in the same office space, room, or building.

**WAN** – (wide area network): The computers are in different geographic locations and are connected by telephone lines or radio waves.

## **NWay Protocol**

A network protocol that can automatically negotiate the highest possible transmission speed between two devices.

## **P**

### **PCM**

PCM (Pulse Code Modulation) is a technique for converting analog audio signals into digital form for transmission.

### **PING**

Packet Internet Groper, a utility used to determine whether a specific IP address is accessible. It functions by sending a packet to the specified address and waits for a reply. It is primarily used to troubleshoot Internet connections.

### **PPPoE**

Point-to-Point Protocol over Ethernet. PPPoE is a specification for connecting the users on an Ethernet to the Internet through a common broadband medium, such as DSL or cable modem. All the users over the Ethernet share a common connection.

## **Protocol**

Communication on the network is governed by sets of rules called protocols. Protocols provide the guidelines devices use to communicate with each other, and thus they have different functions. Some protocols are responsible for formatting and presenting and presenting data that will be transferred from file server memory to the file server's network adapter Others are responsible for filtering information between networks and forwarding data to its destination. Still other protocols dictate how data is transferred across the medium, and how servers respond to workstation requests and vice versa. Common network protocols



responsible for the presentation and formatting of data for a network operating system are the Internetwork Packet Exchange (IPX) protocol or the Internet Protocol (IP). Protocols that dictate the format of data for transferers the medium include token-passing and Carrier Sense Multiple Access with Collision Detection (CSMA/CD), implemented as token-ring, ARCNET, FDDI, or Ethernet. The Router Information Protocol (RIP), a part of the Transmission Control Protocol/Internet Protocol (TCP/IP) suite, forwards packets from one network to another using the same network protocol.

## **R**

### **RJ-45**

RJ-45 connector is used for Ethernet cable connections.

### **Router**

A router is the network software or hardware entity charged with routing packets between networks.

## **S**

### **Server**

It is a simple computer that provides resources, such as files or other information.

### **SIP**

SIP (Session Initiated Protocol) is a standard protocol that delivers the real-time communication for Voice over IP (VoIP), which establishes sessions for features such as audio and video conferencing.

### **SMTP**

The Simple Mail Transfer Protocol is used for Internet mail.

### **SNMP**

Simple Network Management Protocol. SNMP was designed to provide a common foundation for managing network devices.

### **Station**

In LANs, a station consists of a device that can communicate data on the network. In FDDI, a station includes both physical nodes and addressable logical devices. Workstations, single-attach stations, dual-attach stations, and concentrators are FDDI stations.

### **Subnet mask**

In TCP/IP, the bits used to create the subnet are called the

subnet mask.

## **I**

### **(TCP/IP)**

Transmission Control Protocol/Internet Protocol is a widely used transport protocol that connects diverse computers of various transmission methods. It was developed by the Department of Defense to connect different computer types and led to the development of the Internet.

### **Transceiver**

A transceiver joins two network segments together. Transceivers can also be used to join a segment that uses one medium to a segment that uses a different medium. On a 10BASE-5 network, the transceiver connects the network adapter or other network device to the medium. Transceivers also can be used on 10BASE-2 or 10BASE-T networks to attach devices with AUI ports.

## **U**

### **UDP**

The User Datagram Protocol is a connectionless protocol that resides above IP in the TCP/IP suite

### **User Name**

The USERNAME is the unique name assigned to each person who has access to the LAN.

### **Utility**

It is a program that performs a specific task.

### **UTP**

Unshielded twisted-pair. UTP is a form of cable used by all access methods. It consists of several pairs of wires enclosed in an unshielded sheath.

## **W**

### **WAN**

Wide-Area Network. A wide-area network consists of groups of interconnected computers that are separated by a wide distance and communicate with each other via common carrier telecommunication techniques.

### **WEP**

WEP is widely used as the basic security protocol in Wi-Fi networks, which secures data transmissions using 64-bit or 128-bit encryption.

<b>Windows</b>	Windows is a graphical user interface for workstations that use DOS.
<b>WPA</b>	WPA (Wi-Fi Protected Access ) is used to improve the security of Wi-Fi networks, replacing the current WEP standard. It uses its own encryption, Temporal Key Integrity Protocol (TKIP), to secure data during transmission.
<b>WPA2</b>	Wi-Fi Protected Access 2, the latest security specification that provides greater data protection and network access control for Wi-Fi networks. WPA2 uses the government-grade AES encryption algorithm and IEEE 802.1X-based authentication, which are required to secure large corporate networks.

## **Limited Warranty**

TRENDnet warrants its products against defects in material and workmanship, under normal use and service, for the following lengths of time from the date of purchase.

### TV-IP410/TV-IP410W– 3 Years Warranty

AC/DC Power Adapter, Cooling Fan, and Power Supply carry 1 year warranty.

If a product does not operate as warranted during the applicable warranty period, TRENDnet shall reserve the right, at its expense, to repair or replace the defective product or part and deliver an equivalent product or part to the customer. The repair/replacement unit's warranty continues from the original date of purchase. All products that are replaced become the property of TRENDnet. Replacement products may be new or reconditioned. TRENDnet does not issue refunds or credit. Please contact the point-of-purchase for their return policies.

TRENDnet shall not be responsible for any software, firmware, information, or memory data of customer contained in, stored on, or integrated with any products returned to TRENDnet pursuant to any warranty.

There are no user serviceable parts inside the product. Do not remove or attempt to service the product by any unauthorized

service center. This warranty is voided if (i) the product has been modified or repaired by any unauthorized service center, (ii) the product was subject to accident, abuse, or improper use (iii) the product was subject to conditions more severe than those specified in the manual.

Warranty service may be obtained by contacting TRENDnet within the applicable warranty period and providing a copy of the dated proof of the purchase. Upon proper submission of required documentation a Return Material Authorization (RMA) number will be issued. An RMA number is required in order to initiate warranty service support for all TRENDnet products. Products that are sent to TRENDnet for RMA service must have the RMA number marked on the outside of return packages and sent to TRENDnet prepaid, insured and packaged appropriately for safe shipment. Customers shipping from outside of the USA and Canada are responsible for return shipping fees. Customers shipping from outside of the USA are responsible for custom charges, including but not limited to, duty, tax, and other fees.

**WARRANTIES EXCLUSIVE:** IF THE TRENDNET PRODUCT DOES NOT OPERATE AS WARRANTED ABOVE, THE CUSTOMER'S SOLE REMEDY SHALL BE, AT TRENDNET'S OPTION, REPAIR OR REPLACE. THE FOREGOING WARRANTIES AND REMEDIES ARE EXCLUSIVE AND ARE IN LIEU OF ALL OTHER WARRANTIES, EXPRESSED OR IMPLIED, EITHER IN FACT OR BY OPERATION OF LAW, STATUTORY OR OTHERWISE, INCLUDING WARRANTIES

OF MERCHANTABILITY AND FITNESS FOR A PARTICULAR PURPOSE. TRENDNET NEITHER ASSUMES NOR AUTHORIZES ANY OTHER PERSON TO ASSUME FOR IT ANY OTHER LIABILITY IN CONNECTION WITH THE SALE, INSTALLATION MAINTENANCE OR USE OF TRENDNET'S PRODUCTS.

TRENDNET SHALL NOT BE LIABLE UNDER THIS WARRANTY IF ITS TESTING AND EXAMINATION DISCLOSE THAT THE ALLEGED DEFECT IN THE PRODUCT DOES NOT EXIST OR WAS CAUSED BY CUSTOMER'S OR ANY THIRD PERSON'S MISUSE, NEGLIGENCE, IMPROPER INSTALLATION OR TESTING, UNAUTHORIZED ATTEMPTS TO REPAIR OR MODIFY, OR ANY OTHER CAUSE BEYOND THE RANGE OF THE INTENDED USE, OR BY ACCIDENT, FIRE, LIGHTNING, OR OTHER HAZARD.

LIMITATION OF LIABILITY: TO THE FULL EXTENT ALLOWED BY LAW TRENDNET ALSO EXCLUDES FOR ITSELF AND ITS SUPPLIERS ANY LIABILITY, WHETHER BASED IN CONTRACT OR TORT (INCLUDING NEGLIGENCE), FOR INCIDENTAL, CONSEQUENTIAL, INDIRECT, SPECIAL, OR PUNITIVE DAMAGES OF ANY KIND, OR FOR LOSS OF REVENUE OR PROFITS, LOSS OF BUSINESS, LOSS OF INFORMATION OR DATE, OR OTHER FINANCIAL LOSS ARISING OUT OF OR IN CONNECTION WITH THE SALE, INSTALLATION, MAINTENANCE, USE, PERFORMANCE, FAILURE, OR INTERRUPTION OF THE POSSIBILITY OF SUCH DAMAGES, AND LIMITS ITS LIABILITY TO REPAIR, REPLACEMENT, OR REFUND OF THE PURCHASE PRICE PAID, AT TRENDNET'S OPTION. THIS DISCLAIMER OF LIABILITY

FOR DAMAGES WILL NOT BE AFFECTED IF ANY REMEDY PROVIDED HEREIN SHALL FAIL OF ITS ESSENTIAL PURPOSE.

**Governing Law:** This Limited Warranty shall be governed by the laws of the state of California.

Some TRENDnet products include software code written by third party developers. These codes are subject to the GNU General Public License ("GPL") or GNU Lesser General Public License ("LGPL").

Go to <http://www.trendnet.com/gpl> or <http://www.trendnet.com> Download section and look for the desired TRENDnet product to access to the GPL Code or LGPL Code. These codes are distributed WITHOUT WARRANTY and are subject to the copyrights of the developers. TRENDnet does not provide technical support for these codes. Please go to <http://www.gnu.org/licenses/gpl.txt> or <http://www.gnu.org/licenses/lgpl.txt> for specific terms of each license.







**TRENDnet**<sup>®</sup>

## Product Warranty Registration

Please take a moment to register your product online.  
Go to TRENDnet's website at <http://www.trendnet.com/register>